



## Corrosion and Galvanic behavior of Copper, Carbon steel and Zinc Couples in (3.5 %wt) NaCl Solution

Jamal M. Ali      Qasim M. Abbas

Department of Chemical Engineering /University of Technology

Email: jmal\_ali2003@yahoo.com / P.O.box:35010

(Received 27 January 2009; accepted 7 September 2009)

### Abstract

The galvanic corrosion of the (Cu - Fe), (Cu - Zn) and (Fe - Zn) couples have been investigated in 3.5% NaCl solution, 40°C, different velocities ( $Re = 5000, 10000$  and  $15000$ ) and different area ratio's of cathode to anode ( $AR = 0.5, 1$  and  $2$ ), by using commercial metal pipe (cylindrical tube). The Zero Resistance Ammeter has been used to measure the galvanic current ( $I_g$ ) and galvanic potential ( $E_g$ ) with time. The galvanic current density increases with increasing velocity ( $Re$ ) and the area ratio ( $AR$ ). The galvanic potential ( $E_g$ ) is shifted to less negative with increasing velocity ( $Re$ ) and the area ratio ( $AR$ ). A statistical relations for the galvanic current density and galvanic potential as a function of ( $Re$ ), and the area ratio had been created depending on Quasi-Newton method. There is good agreement between experimental and predicted results.

**Keywords:** Corrosion behavior in copper, galvanic corrosion

### 1. Introduction

Galvanic corrosion is the corrosion that results when two dissimilar metals with different potentials are placed in electrical contact in an electrolyte. A difference in electrical potential exists between the different metals and serves as the driving force for electrical current flow through the corrodant or electrolyte. This current result in corrosion of one of the metals. The larger the potential difference, the greater the probability of galvanic corrosion. Galvanic corrosion only causes deterioration of one of the metals.

The less resistant, active metal (high potential) becomes the anodic corrosion site. The stronger, more noble metal is cathodic and protected. If there were no electrical contact, the two metals would be uniformly attacked by the corrosive medium as if the other metal were absent. Two locations susceptible to galvanic corrosion are a piping transition from one metal to another and a sacrificial anode (such as zinc) <sup>[1]</sup>. Galvanic corrosion is a simple concept of electrical potential and electron transfer.

Three components are needed to enable the action of a galvanic cell:

1. Dissimilar metals with differing electrical potentials.
2. A common electrolyte, a conductive solution or any solution that will conduct electricity.
3. An electronic connection or metals in direct contact that will enable the transfer of electrons from one metal to the other.

Altering the system can eliminate or reduce the harmful effects of galvanic corrosion <sup>[2]</sup>. Many factors including the electrochemical ones determine whether or not galvanic corrosion will occur, as: area ratio ( $AR$ ), distance apart in the galvanic series, mass transport, distance effect, alloy composition, bulk solution properties and reaction kinetics.

Pryor <sup>[3]</sup> investigated the galvanic corrosion of Al/steel couple in solution containing chloride and found that aluminum completely protects steel cathodically within the pH range 0-14; the galvanic current and the corrosion rate of aluminum are at a minimum in the nearly neutral pH range.

Mansfeld [4] investigated the effect of variation in area ratio of two metals in a galvanic couple in which three common cases of corrosion of galvanic couples have been treated. In case 1, it was assumed that the galvanic potential would be in a region where only significant process on the more active metal is dissolution. On the other hand the only significant process on the more noble metal is reduction of oxidizer. In this case, a measurement of the galvanic current density will give an exact value or the dissolution rate of the anode. In case 2, it was assumed that coupling of more active metal to more noble metal causes only such a small shift of the potential of more active metal that a cathodic as well as an anodic process takes place at significant rates on more active metal and Tafel behavior is therefore not observed. In this case, the galvanic current density is always smaller than the dissolution current density of the anode. It is assumed that the corrosion rate of more active metal is controlled by the diffusion rate of the oxidizer ( $O_2$ ) to the surface of more active metal, and more noble metal metal is acting as an oxygen electrode.

Mansfeld et al. [5] investigated the effect of area ratio on the galvanic corrosion and found that the galvanic current density  $i_g^A$  with respect to the anode is directly proportional to the area ratio,

$$i_g^A = K_1 A_c / A_a \quad \dots (1)$$

Mansfeld [6] studied the instrumentation for measurement of galvanic current as a function of velocity of metal / electrolyte and found that the relationship between galvanic current density and velocity is:

$$i_g = \text{const.} + \text{const.}(\sqrt{V}) \quad \dots (2)$$

Tsujino et al. [7] Studied the galvanic corrosion of steel coupled to noble metals (Pt, Cu, 304 stainless steel), in sodium chloride solution and found that the local currents on the steel depend on the area ratio of the steel to the cathodic metal and these currents are not related to the concentration of sodium chloride(0.5 – 4)%wt. in neutral solutions.

Budinski et al. [8] predicted the electrochemical criterion for the development of galvanic coating alloys for steel in air saturated NaCl solution and found that when galvanically coupled to steel in 5wt. % NaCl, zinc effectively protects the steel against corrosion. The corrosion

rate of zinc, however, is very high. The cathodic protection potential determined for steel in 5wt% NaCl was  $-0.725$  V, vs.SCE for a corrosion rate of less than 1 mpy.

Kullter <sup>[9]</sup> describes the galvanic corrosion of carbon steel and its interaction with coating material such as aluminum, cadmium and zinc, found that extremely slow degradation of aluminum and cadmium, however, can be expected in salt spray, while zinc coatings experienced the highest corrosion attack.

Wilhelm <sup>[10]</sup> work was conducted to quantify the magnitude of galvanic currents and potentials that exist between metals (iron, copper, titanium, aluminum, chromium and nickel) and their corrosion products in oxygen containing environments, and found that oxide films on metals that arise because of passivation in aqueous environments or that develop from thermal treatment during processing provide a galvanic couple to the metal substrate. The magnitude of the galvanic interaction may be deduced by consideration of the electronic properties and thickness of the films.

Olsson et al. <sup>[11]</sup> investigated the galvanic action in heat exchangers working with seawater as cooling medium and found that presence of sand,  $H_2S$ ,  $CO_2$  and  $NH_3$  accelerates localized attacks on copper based alloys.

Venugopalan et al. [12] investigated the galvanic corrosion in Ti-6Al-4V/ Co-Cr-Mo alloy, and found that the galvanic corrosion tests can be used to evaluate new surface modification that may enhance the performance of the alloy couple electrochemically.

Stephen [13] studied the galvanic action in zinc alloys, and found that the corrosion of the anodic metal is both more rapid and more damaging as the voltage difference increases and as the cathode area increases relative to the anode area.

Wilhelm [14] studied galvanic corrosion between dissimilar materials using laboratory simulation of oil/gas production environments. Galvanic corrosion of materials used in production equipment (9Cr, 13Cr, N/C42, SM2550, Beta- CTi, and C-276) was studied in corrosive environments, which included sweet well produced fluids, sour well produced fluids, heavy brine packer fluids, and acid zing fluids. Corrosion coupons of various geometries were used to measure corrosion rates and morphologies. Electrochemical measurements were performed to determine potentials and current densities. The experimental study found

that the severity of galvanic attack is a strong function of the type of corrosion products that come from a metal surface.

## 2. Experimental Work

Throughout this investigation the corrosion of carbon steel, zinc and copper materials in coupled conditions (galvanic action) was studied in 3.5% sodium chloride solution under different flow conditions at constant temperature ( $40^{\circ}\text{C} \pm 0.5$ ).

One kind of electrochemical measurement was conducted, galvanic current and galvanic potential measurements. The specimens have inside diameter of (2.6cm), length (2.4cm) and outside diameter of (2.8cm) and were used as received. The test section was mounted horizontally and preceded by (50cm) entrance region (i.e.  $L/d=10$ ) of Q.V.F. tube to ensure fully developed flow condition before the solution reaching the specimens [15, 16]. The test section was followed by (35cm) exit length to avoid disturbance at the outlet [17, 18].

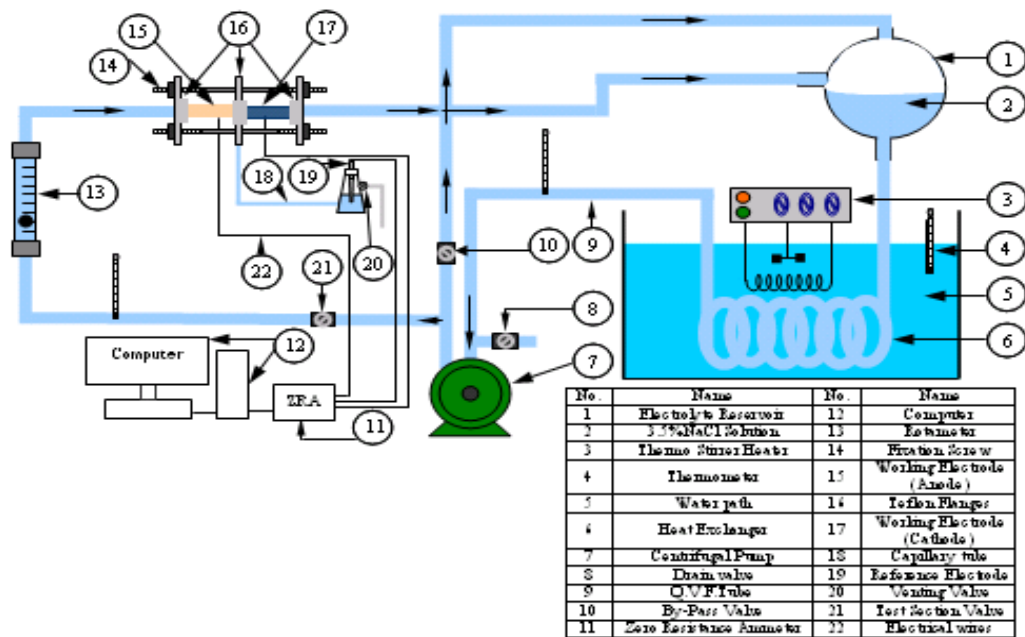

Fig. 1. Experimental Apparatus.

The effect of velocity [ $Re = 5000, 10000$  and  $15000$ ] and different area ratios [ $AR = 0.5, 1$  and  $2$ ] of cathode to anode for different galvanic couples (Cu-Fe), (Cu-Zn) and (Fe-Zn) were thoroughly investigated. The flow system was designed to contain the items as mentioned in Fig.(1).

In the Galvanic measurements, the two test sections are composed of the following components: Working Electrode (Cathode); (Cu, Fe), Working Electrode (Anode);(Zn, Fe), Reference Electrode;(SCE)and Zero Resistance Ammeters (ZRA). (ZRA) is a device used to measure the galvanic current ( $I_g$ ) and galvanic potential ( $E_g$ ), which was first simply constructed by Mansfeld et al. [19]. This was measured using

digital millivoltmeter. The galvanic current was calculated from potential measurement. Experimental procedure, for coupled metals, the galvanic corrosion current generated between the two metals and galvanic potential was measured at the same time. Each test was performed twice and if repeatability was in doubt a third test was carried out.

## 3. Results and Discussion

The results presented in Figs. (2) through (4) which show clearly the behaviors of galvanic current density ( $I_g$ ) and galvanic potential ( $E_g$ ) with time for area ratio of (0.5, 1 and 2) and

Reynolds number of (5000, 10000 and 15000) at steady state. (e.g. for Re=5000 and AR=0.5, (Cu-Fe) couple, steady state galvanic current density

( $I_g$ ) and galvanic potential ( $E_g$ ) and after 4 hours was ( $0.956A/m^2, -646.948mV$ )).

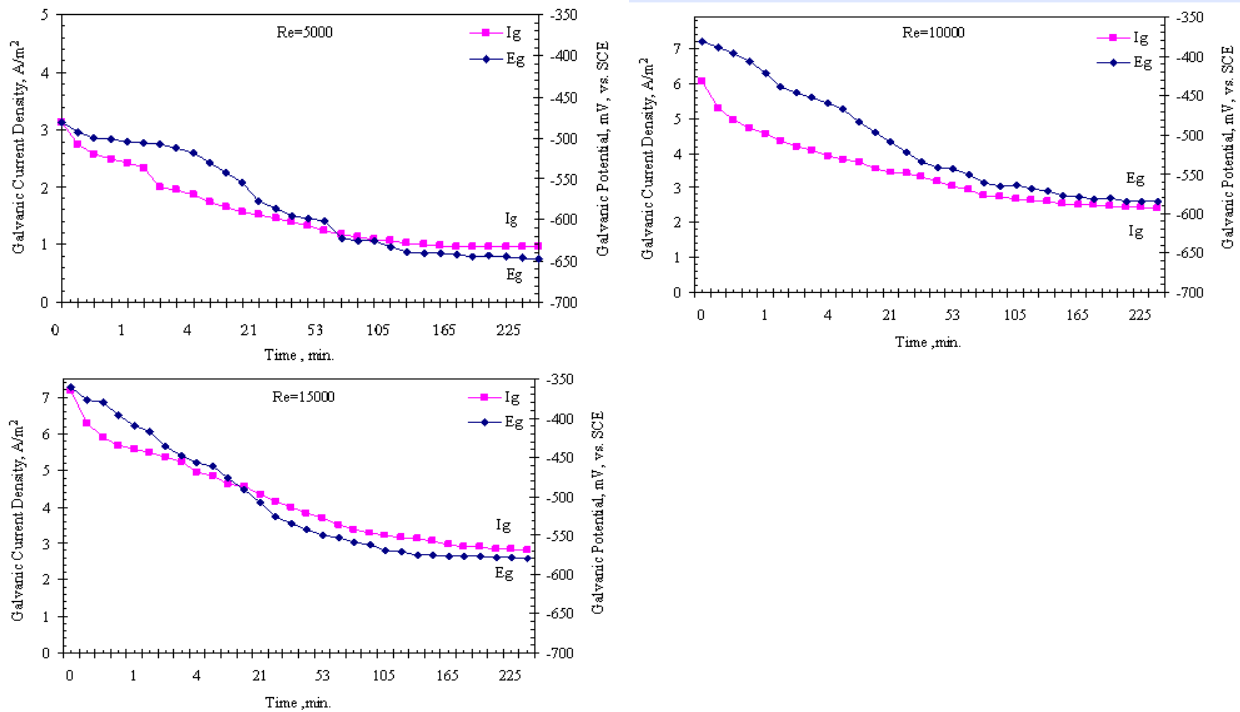

Fig. 2. Time Behavior of Galvanic Current Density and Couple Potential (Cu-Fe) Couple, (Re= 5000, 10000 and 15000) and AR=0.5.

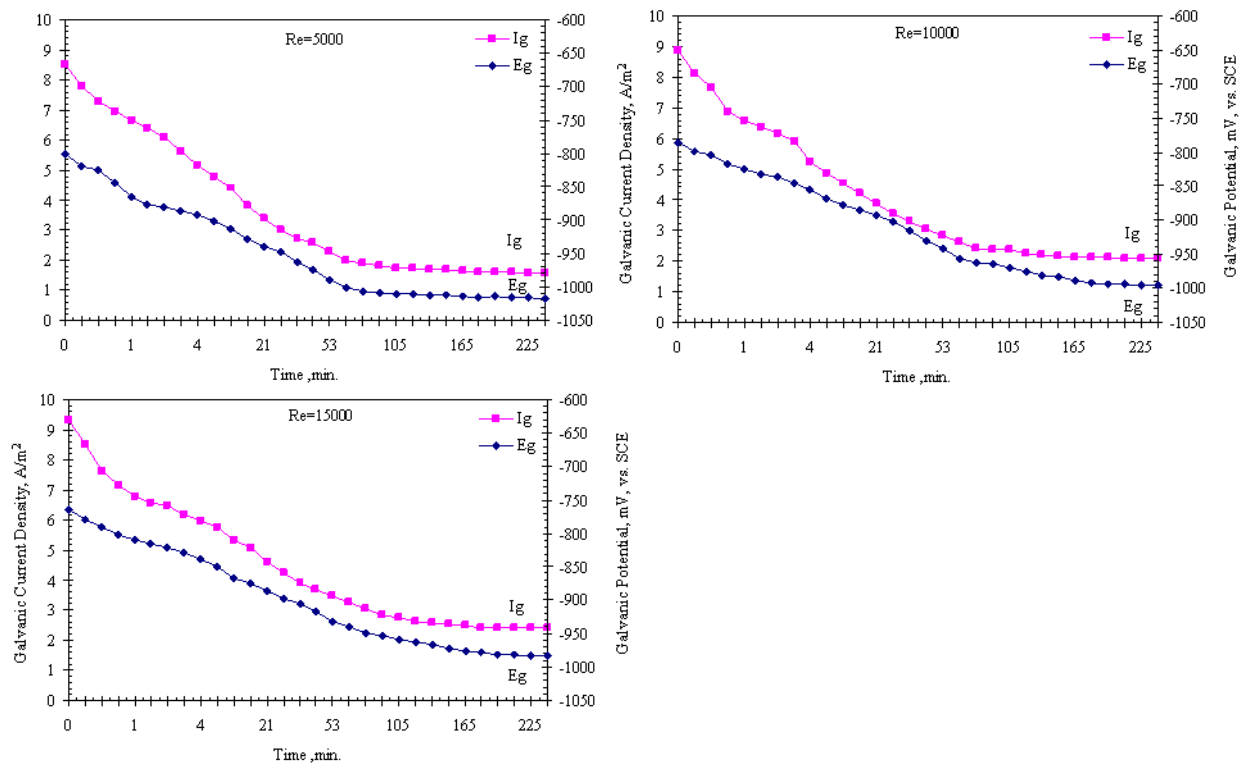

Fig. 3. Time Behavior of Galvanic Current Density and Couple Potential (Cu-Zn) Couple, (Re= 5000, 10000 and 15000) and AR =1.

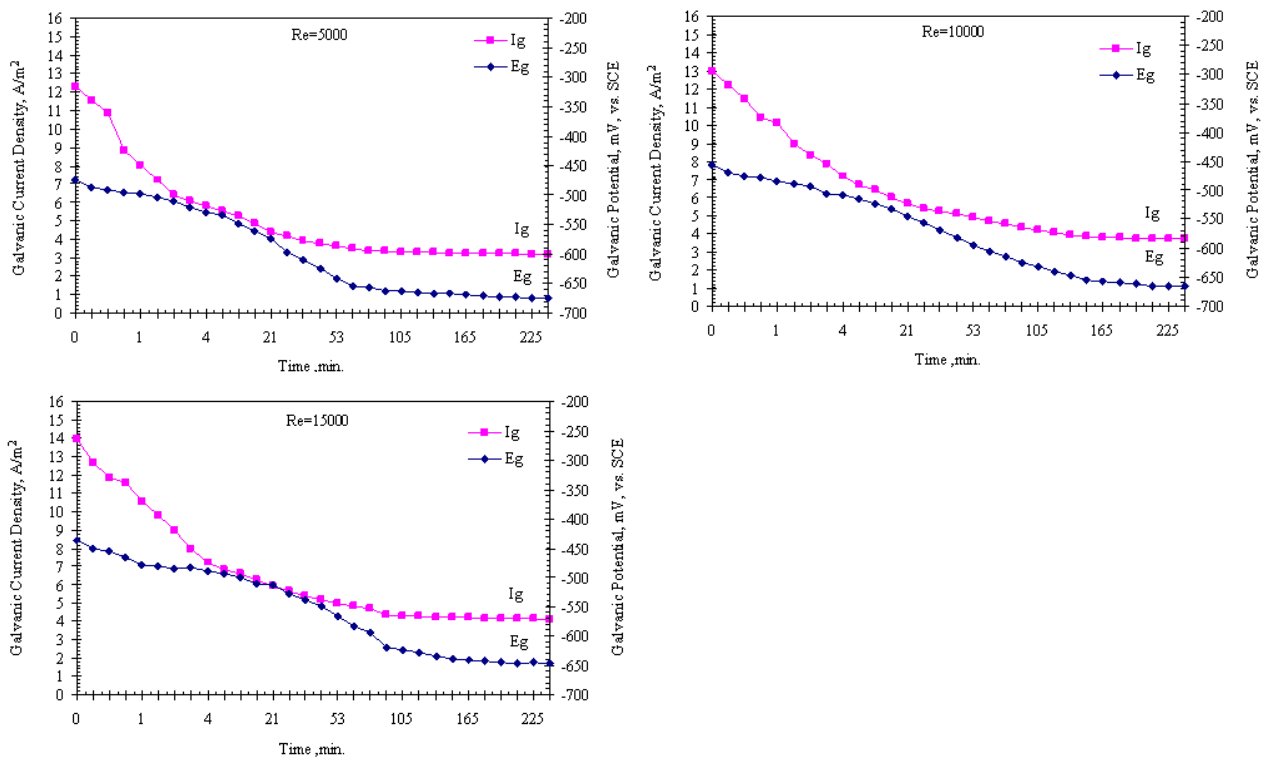

Fig. 4. Time behavior of galvanic current density and couple potential (Fe-Zn) couple, (Re= 5000, 10000 and 15000) and AR=2.

The initial galvanic current density is maximum value and decreases slowly until steady state galvanic current is reached. This maximum value is apparently dependent on the (AR and Re). Because the metal surfaces at the beginning of the test were clean and active for corrosion to ensure but during a later stage corrosion product film will be formed which will decrease the activity of the metal surfaces and impede the diffusion of oxygen. This was noticed with time as the electrolyte colour changed due to formation of corrosion products. This time behavior which is in accordance with what were noticed by others [20, 21, 22]. The galvanic potential ( $E_g$ ) is changed with time to more negative values, where the ( $E_g$ ) is recorded at each minute for an experimental run of four hours long. Precisely the galvanic potential ( $E_g$ ) became rapidly more negative in the first (30-45) min., and then the curve converged to slower rate, that is because of the formation of the  $OH^-$  ions at a high rate and grouping on the electrodes [23].

### 3.1. Reynolds Number Effect

From Figs. (2) through (4), it is clear the value of the galvanic current density ( $I_g$ ) increases and galvanic potential ( $E_g$ ) is shifted to a less negative value with increasing Re. This is due to the increase in the amount of oxygen transport to the surface, via increasing eddy diffusion. As a consequence of increasing the ( $I_g$ ) the galvanic potential is shifted to more positive. The relationship between galvanic potential and area ratio shows that increasing area ratio increases the galvanic potential in the more noble direction as shown in Fig.(5) for different flow conditions. This is due to the increased influence in the more noble metal.

The average galvanic current density ( $I_g$ ) was determined graphically by calculating the area under the curve from the galvanic current-time curve. A suitable equation has been created by using GRAPHER Package PROGRAM. Integration applied to each equation, integral current time for (0-240min.) time interval, has been calculated for each case. The average values of galvanic current density are listed in Tables (1) to (3).

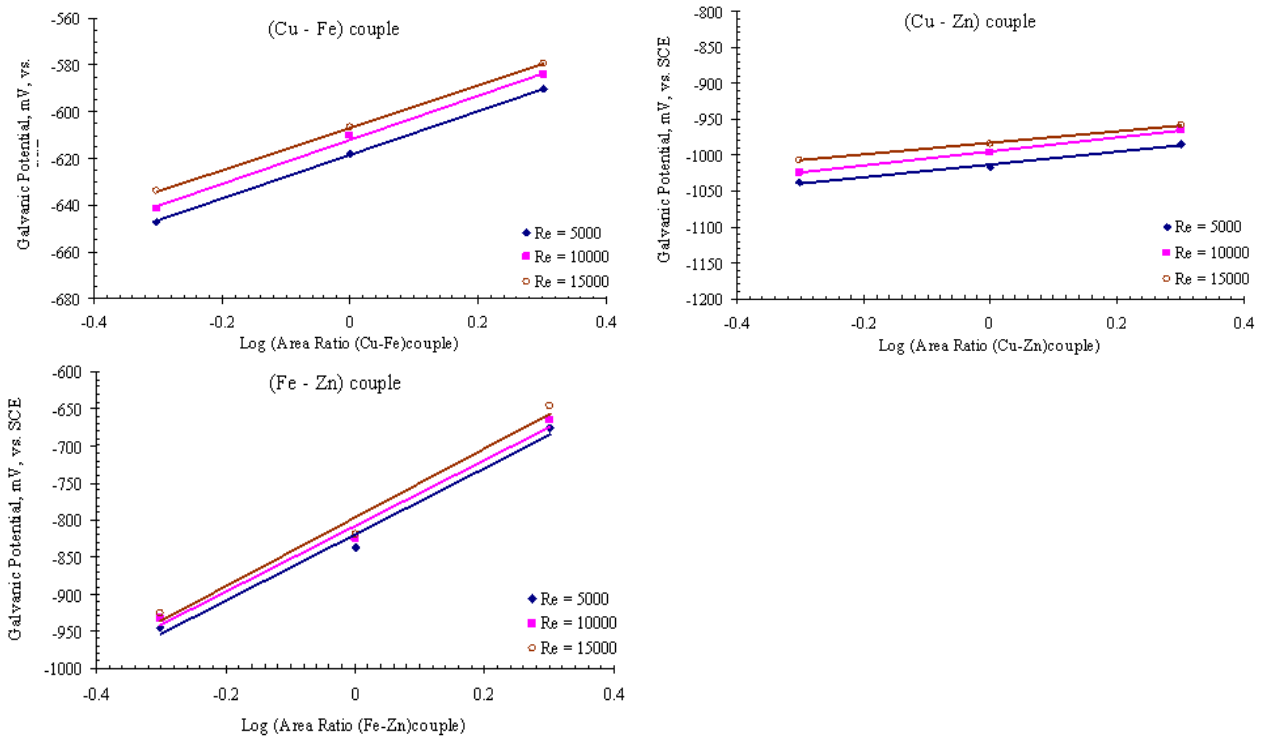

Fig. 5. The Area Ratio Effect on the Galvanic Potential for (Cu-Fe), (Cu-Zn) and (Fe-Zn) Couples at Different Re.

Table 1, Average Galvanic Current Density of (Cu-Fe) Couple Under Different Flow Conditions and Area Ratios.

Area Ratio (Cu-Fe)couple	Galvanic Current (A/m <sup>2</sup> )		
	Re = 5000	Re = 10000	Re = 15000
0.5	1.147	1.599	1.794
1	1.653	2.115	2.478
2	2.315	2.796	3.361

Table 2, Average Galvanic Current Density of (Cu-Zn) Couple Under Different Flow Conditions and Area Ratios.

Area Ratio (Cu-Zn)couple	Galvanic Current (A/m <sup>2</sup> )		
	Re = 5000	Re = 10000	Re = 15000
0.5	1.804	2.242	2.475
1	2.152	2.619	3.105
2	2.93	3.645	3.741

Table 3, Average Galvanic Current Density of (Fe-Zn) Couple Under Different Flow Conditions and Area Ratios.

Area Ratio (Fe-Zn)couple	Galvanic Current (A/m <sup>2</sup> )		
	Re = 5000	Re = 10000	Re = 15000
0.5	2.401	2.762	3.277
1	2.811	3.443	4.062
2	3.501	4.411	4.712

The relationship between galvanic current density ( $I_g$ ) and flow rate (Re.) is shown in Fig.(6) for different area ratio of the cathode to anode. The galvanic current density increases with increasing Reynolds number and area ratio. As the area ratio

increases, the influence of Reynolds number becomes more significant as shown at area ratio of 2, A linear relationship is shown between Log  $I_g$  and Log Re, which is in agreement with what was found by others [21, 24].

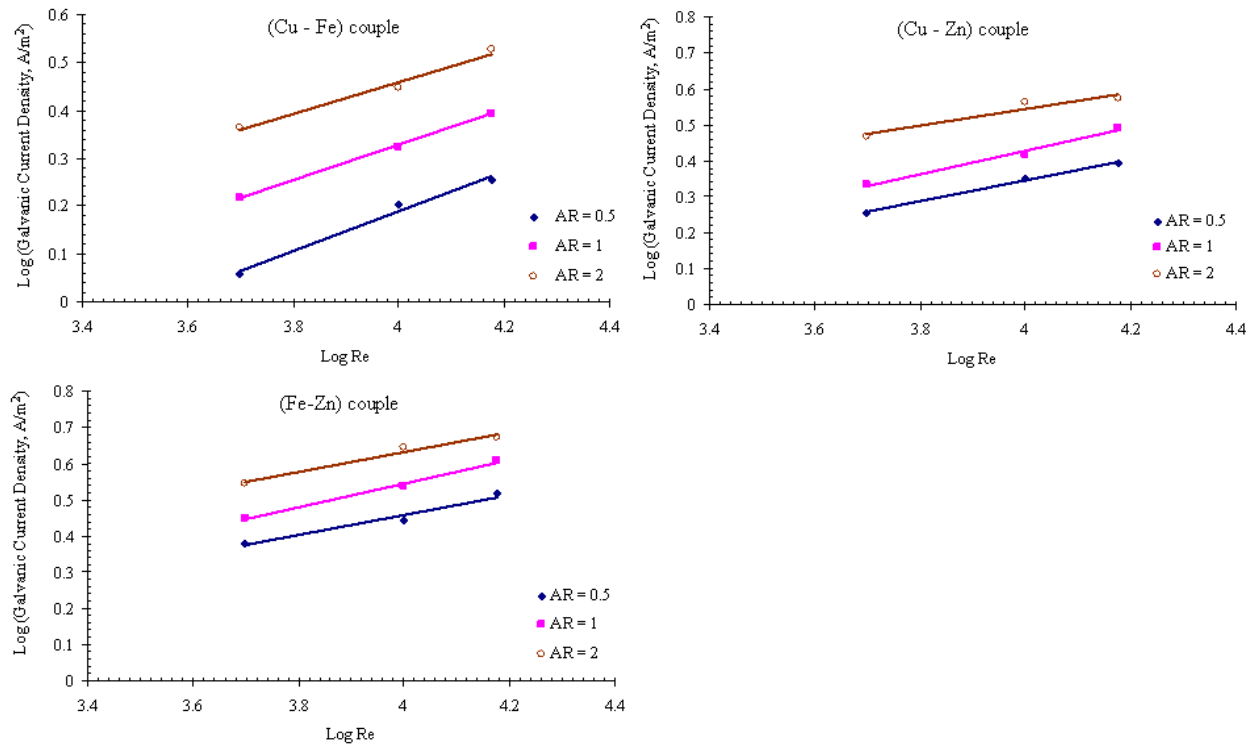

Fig. 6. Effect of Re on the Galvanic Current Density for (Cu-Fe), (Cu-Zn) and (Fe-Zn) Couples at Different AR in 3.5% NaCl Solution at 40 °C.

### 3.2. Area Ratio Effect

Galvanic current density ( $I_g$ ) increases with increasing area ratio (AR) while galvanic potential moves in the noble direction due to increasing corrosion current with increasing cathodic area. Area ratio plays an important role in galvanic corrosion as it was found from the results. It plays a comprehensive role as shown

in Figs. (2) to (4) and Tables (1) to (3) which show that increase in Area Ratio ( $A_c/A_a$ ) increases ( $I_g$ ). Increasing area ratio leads to increase in the exposed area to corrosive solution, i.e. the more negative electrode will corrode and the more positive electrode is protected.

The total surface area is equal to the summation of the anode surface area and cathode surface area as shown in Table (4).

Table 4, Relationship Between Area Ratio and Surface Total Area ( $A_t$ ).

AR ( $A_c/A_a$ )	$A_c$ (cm <sup>2</sup> )	$A_a$ (cm <sup>2</sup> )	$A_t = A_c + A_a$ (cm <sup>2</sup> )
0.5	8.1681	16.3363	24.5044
1	16.3363	16.3363	32.6726
2	32.6726	16.3363	49.0089



One can notice from this table that the total area of metals ( $A_t$ ) increases with increasing area ratio which leads to increase in average galvanic current ( $I_{g(av.)}$ ) as shown in Tables (1) to (3). In this study, the effect of area ratio of the cathode to

anode on the galvanic current is clearly shown in Fig.(7) which show increasing galvanic current with increasing AR for given  $Re$ . These findings are advocating the results previously noticed by Tsujino and Miyase [7].

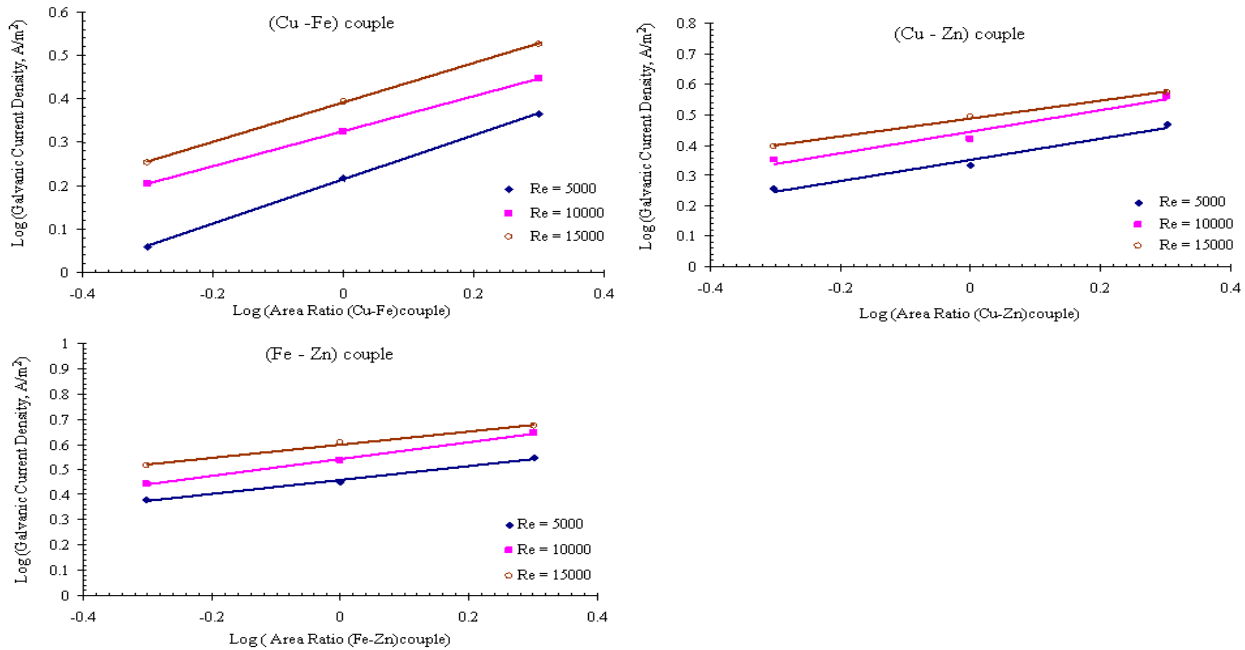

Fig. 7. The relationship between galvanic current density and area ratio For (Cu - Fe), (Cu - Zn) and (Fe - Zn) couple.

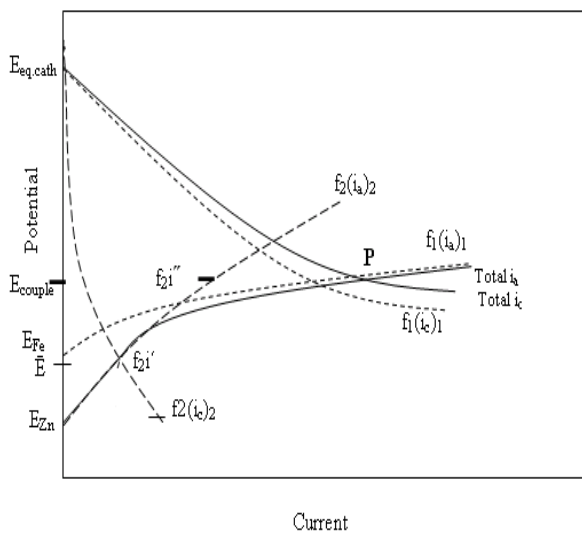

Fig. 8. Behaviour of a Metal Couple Fe-Zn,  $AR \gg 1$  Produces Galvanic Attack of Zn (Schematic) [24].

Consider the situation in Fig.(8) where the area ratio  $f_1/f_2$  is very large, i.e. the noble metal (Fe) greatly exceeds by one the active metal (Zn) in

area. The total anodic and cathodic current curves of Fig.(8) have been constructed by summing the currents  $f_1i_1$  and  $f_2i_2$  according to the Eq.(3) [24]:

$$i_{total} = f_1i_1 + f_2i_2 \quad \dots (3)$$

Clearly, in the absence of Fe, the corrosion of the active metal Zn would be represented by the  $(\bar{E}, f_2i')$ . If the noble metal Fe is also present the overall corrosion situation is represented by the point of intersection of the two total curves at P. At the potential  $E_{couple}$ , the corrosion current of Zn is  $f_2i''$ , so that Zn is now corroding at a current density of  $i''$  as against  $i'$  shown previously.

The intensity of attack on the active metal is greatly enhanced (in the ratio  $i'' / i'$ ) when the metal is coupled to a large area of a more noble metal Fe. In Fig.(8) the distribution of the various anodic and cathodic reactions is schematically represented. Zn corrodes rapidly (thick arrow) and most of the electrons generated are fed into Fe where cathodic reaction occurs almost



exclusively. Zn is said to undergo galvanic attack [24].

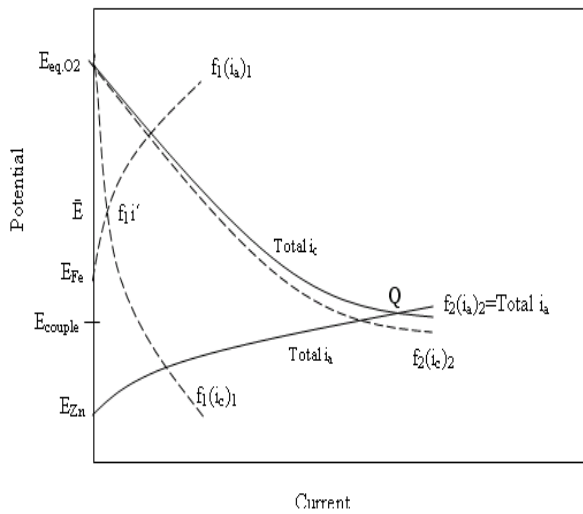

Fig. 9. Behaviour of a metal couple Fe-Zn, AR<<1 produces galvanic attack of Zn (Schematic) [24].

Where  $f_1/f_2$  is very small, i.e. the active metal (Zn) greatly exceeds the noble metal (Fe) by one in area; the situation is represented in Fig.(9). Again, the total anodic and cathodic curves have been constructed and they can be seen in Fig.(9) these intersect at Q, where the potential  $E_{couple}$  has now moved in the active direction relative to P in Fig.(8). in these circumstances the presence of Fe makes very little difference to Zn. However, the interest should be directed to Fe. It may be seen that, where Zn is not present, corrosion of Fe would normally take place at a potential  $\bar{E}$  and current  $f_{1i}'$ . But because the potential of the couple (viz. at Q) is now below the reversible potential  $E_{Fe}$ , corrosion of Fe now ceases

altogether because there can be no net anodic reaction at the Fe|  $Fe^{++}$  interface. As a result, Fe is said to be galvanically protected. Fig.(9) shows the distribution of reaction [25]. This is also the situation for the (Cu-Fe) couple and (Cu-Zn) couple where Cu is totally protected.

### 3.3. Statistical Relationships

The data obtained from monitoring the galvanic current density and galvanic potential with time as shown in previously in Figs. (2) through (4), are presented mathematically by a regression analysis to give:

$$I_g = a + b (Re) + d (AR). \dots (4)$$

$$E_g = a + b (Re) + d (AR). \dots (5)$$

where:

$I_g$  = galvanic current density ( $A/m^2$ ) at steady state.

Re = Reynolds number.

$E_g$  = galvanic potential (mV) at steady state.

AR =area ratio.

These equations have been created depending on “Quasi - Newton method”, which are included in statistical program package. The mathematical expression for different couples are shown in Table (5).

The comparison between the measured galvanic current and potential with predicted values by the relations in the Table (5) show a good agreement between them as shown in Table (6). From statistical point of view they are absolutely accepted, (i.e., c.c=0.9 – 1).

Table 5, The Mathematical Expression for Different Couples

Couple	The relations	C.C	Mean error (%)
Cu-Fe	$I_g = 0.144167 + 0.000075(Re) + 0.773571(AR)$	0.989	5.255
	$E_g = -665.988 + 0.001167 (Re) + 35.96557 (AR)$	0.978	2.51
Cu-Zn	$I_g = 0.470167 + 0.000086(Re) + 0.672048(AR)$	0.988	1.55
	$E_g = -1067.8 + 0.002975(Re) + 34.95643(AR)$	0.989	9.845
Fe-Zn	$I_g = 0.746833 - 0.000103(Re) + 0.965952(AR)$	0.974	3.72
	$E_g = -1038.85 + 0.002242(Re) + 178.7616(AR)$	0.999	1

#### 4. Conclusions

From present study the following points can be concluded:

1. Copper is a good cathode, carbon steel and zinc worked as efficient sacrificial anodes in the environment of 3.5% NaCl solution at 40°C and a variable Reynolds number.
2. Galvanic current density ( $I_g$ ) for different couples (Cu-Fe, Cu-Zn and Fe-Zn) increases with increasing Reynolds number and area ratio of metals.
3. Galvanic Potential for different couples (Cu-Fe, Cu-Zn and Fe-Zn) is less negative with increasing Reynolds number and area ratio.
4. Area ratio plays an important role in increasing the galvanic attack in most of the cases.
5. Mathematical expressions for galvanic potential and galvanic current density as a function of Re and AR for the various couples give good agreement between the predicted and calculated values.

Table 6,

A Comparison Between Predicted and Experimental Values of Galvanic Corrosion and Galvanic Potential of Different Couples in 3.5 nacl Solution and 40c°, Under Different Flow Conditions and Area Ratio.

Re.No.	Area ratio	Galvanic Potential (Eg), "mV"					
		Experimental			Predicted		
		Cu-Fe	Cu-Zn	Fe-Zn	Cu-Fe	Cu-Zn	Fe-Zn
5000	0.5	-646.95	-1038.3	-945.05	-642.2	-1035.5	-938.3
10000		-641.34	-1024.4	-932.15	-636.3	-1020.6	-927.03
15000		-634.03	-1007.02	-924.85	-630.5	-1005.7	-915.84
5000	1.0	-618.03	-1016.9	-837.16	-624.2	-1017.9	-848.9
10000		-610.14	-996.42	-825.4	-618.4	-1003.1	-837.7
15000		-606.9	-983.95	-819.12	-612.5	-988.2	-826.5
5000	2.0	-590.22	-983.96	-675.28	-588.2	-983.01	-670.1
10000		-584.34	-965.54	-665.64	-582.4	-968.14	-658.9
15000		-579.25	-958.93	-646.27	-576.6	-933.26	-647.7

Table 6, Continue

Re.No.	Area ratio	Galvanic Current (Ig), "A/m <sup>2</sup> "					
		Experimental			Predicted		
		Cu-Fe	Cu-Zn	Fe-Zn	Cu-Fe	Cu-Zn	Fe-Zn
5000	0.5	1.147	1.804	2.401	0.907	1.235	1.745
10000		1.599	2.242	2.762	1.283	1.664	2.260
15000		1.794	2.475	3.277	1.659	2.093	2.775
5000	1.0	1.653	2.152	2.811	1.294	1.571	2.228
10000		2.115	2.619	3.443	1.670	2.000	2.743
15000		2.478	3.105	4.062	2.046	2.429	3.258
5000	2.0	2.315	2.930	3.501	2.067	2.243	3.194
10000		2.796	3.645	4.411	2.444	2.672	3.709
15000		3.361	3.741	4.712	2.820	3.101	4.224

## 5. References

- [1] Forms of corrosion, an internet site of Kennedy Space Center of <http://www.tpub.com/content/dueds.htm>, (2001).
- [2] Galvanic Corrosion, PALL MABEE -WAH CHANG, Article given on the internet at the web site <http://www.outlook-U24N2.com>,(2003).
- [3] Pryor, M.J., Corrosion J., No.1, Vol. 14, P.1, (1958).
- [4] Mansfeld, F., Corrosion J.,No. 10, Vol.27, P.(436442),(1971).
- [5] Mansfeld,F.and Kenkel,J.V.,CorrosionScienceJ.,No. 1,V.15,p.239(1975).
- [6] Mansfeld, F., Corrosion J., No.9, Vol.32, P.(380.381),(1976).
- [7] Tsujino, B.,and Miyase,Corrosion J.,No.4,Vol.38,P.(226-230),(1982).
- [8] Budinski, M.K.andWilde, B.E., CorrosionJ.,No.1,vol.43,P.(60-62), (1987).
- [9] Kullter, W., Corrosion Science J., No.2, Vol.28, P.(173-198),(1988).
- [10] Wilhelm, S.M., ASTM STP 979, P.(23- 34), (1988).
- [11] Olsson, A.O. and Newman, M.B., Chemical Engineering World J., No.11, at <http://www.exicom.org/cew>,(1997).
- [12] Venugopulan, R., Justice, T.A., Lucas, I.C. and Lemons, J.E., an INTERNET Article, (2000).
- [13] Stephen, C.D., Article given on the internet at the web site <http://www.ocean.udel.edu>, (2002).
- [14] Wilhelm S.M., Corrosion, No.48, Vol.8, P.(691-703) Aug. (1992).
- [15] Bennett, C. O. and Myers, J. E., Momentum, Heat and Mass Transfer, 3<sup>rd</sup> ed., Mc Graw Hill, United States, (1982).
- [16] Ozisk,M.N.,Heat Transfer, 3<sup>rd</sup> ed., McGraw Hill, New York,(1988).
- [17] Postlethwaite, J.,Fiadzigbe,E.,S.,Corrosion J.Vol.34,No.3, P. 85,(1978).
- [18] Al-Auasi,B.,O., Ph.D.Thesis, University of Al-Nahrain , (2003).
- [19] Mansfeld,F., and Lauer,G., Corrosion J.No.11, vol.26,P.504, (1970).
- [20] Mansfeld,F.and Kenkel,J.V.,Corrosion Science J.,No.11,Vol.15,(1975).
- [21] Ali,J.M., M.Sc. Thesis, University of Baghdad, (1990).
- [22] Al-Kelaby,S.S.B., Ph.D.Thesis, University of Al-Nahrain , (2007).
- [23] Faulkner L.L., S.B.Menkes,Corrosion and Corrosion Protection Handbook, Marcel Dekker, (1983).
- [24] West, J. M., Electrodeposition and Corrosion Processes, Van Nostrand Reinhold Company, 2<sup>nd</sup> ed.,(1971).
- [25] Steigerwald, R. F., Corrosion, No.24,p. 1, (1968).

## التآكل والتصريف الغلفاني لمزدوجات النحاس، الحديد والزنك في محلول كلوريد الصوديوم بتركيز (3.5 wt %)

جمال مانع علي قاسم محمد عباس

قسم الهندسة الكيميائية/الجامعة التكنولوجية  
بغداد/ العراق/ ص.ب. 35010

### الخلاصة

تم دراسة التآكل الكلفاني الناتج من استخدام مزدوجات المعادن (Fe-Zn)، (Cu-Zn)، (Cu-Fe) في محلول كلوريد الصوديوم بنسبة 3.5 % عند درجة حرارة 40 م°، وبحالات جريان مختلفة (Re=5000, 10000, 15000) وبأختلاف نسبة مساحة الكاثود إلى الأنود (AR=0.5, 1.0, 2.0)، وكانت النماذج المستخدمة على الشكل الاسطواني الانبوبي. وتم استخدام (zero resistance ammeter)، لقياس التآكل الكلفاني الناتج من ربط معدنين على شكل مزدوج وكذلك قياس جهد التآكل الكلفاني مع الزمن. من خلال التجارب المجراة لوحظ ان التآكل الكلفاني يزداد بزيادة سرعة الجريان (Re.) ونسبة المساحة (AR)، بينما جهد التآكل الكلفاني يذهب بالاتجاه الأقل سالباً بزيادة السرعة ونسبة المساحة. تم استنتاج علاقات رياضية تربط بين التآكل الكلفاني وبين الجهد الكلفاني مع السرعة متمثلة بـ (Re.) ونسبة المساحة وبالاعتماد على الطرق العددية وبأستخدام البرنامج الاحصائي (Statistica)، وكان هناك تطابق واضح بين النتائج العملية والنظرية المستنتجة.