



INVESTIGATION ON THE MECHANICAL AND METALLURGICAL PROPERTIES OF THE BRAZED ALUMINUM JOINTS USING DIFFERENT AL-SI FILLER ALLOYS AND CLEARANCE APPROACHING

Baha S. Mahdi

U.O.T.- Production Engineering and Metallurgy Dept. Baghdad, Iraq

Email: bahasami1973@gmail.com

Neam Fawzi Mohammed,

MSc Engineer, U.O.T.- Production Engineering and Metallurgy Dept. Baghdad, Iraq

Email: neam_alasady@yahoo.com

Received on 27 October 2016

Accepted on 9 August 2017

Abstract: *The aim of this work is to study the effect of filler metal alloy, on the metallurgical aspects of diffusion rate and mechanical properties of the brazing joint using two types of Silicon-Aluminum filler metal alloys on the commercially aluminum base metal. The brazing process experiments done by joining Al-alloys (1100) type by a brazing process using (AlSi₅, AlSi₁₂) filler metals at 600-650°C. Two types of joint were made, inclined and curvature design. To indicate the brazing joint performance the specimens tested for single shear tensile test and metallurgical testing using optical and scanning electron microscope attached with energy dispersive detector. Diffusion rate results according to joint clearance and brazing time accomplished using optical microscope images for joints cross sections and data gained with assisting of **ImageJ**[®] software. The joint sections analyzed using EDS detector and X-Ray analysis to observe the produced phases. The major phases of brazed joints using 12%Si filler alloy gives (Al, Fe₃Si, Al_{0.3}Fe₃Si_{0.7}) and (Al_{0.3}Fe₃Si_{0.7}) for the 5%Si filler alloy. The two filler alloys (5 and 12%Si) had equivalent tensile strength with respect to the base metal (Al-1100 alloy) of 176 and 128MPa respectively, therefore the maximum joint efficiencies are 170% for AL5%Si filler alloy and 123% for AL12%Si filler alloy which mean that the tensile strength of the brazed joint had values greater than 100%.*

Keywords: Aluminum brazing, eutectic aluminum filler metals, Furnace brazing.

1- INTRODUCTION

The Brazing refers to the joining process of heating a joint to the liquidus temperature of the used filler metal over 450°C. The American Welding Society describes the brazing filler metal as the additional metal when producing a braze. Brazing filler metal is metal or else alloys that must have a melting temperatures



above (450°C) but under those of the metals to be joined. This clearly established the term “brazing filler metal” has replaced some of the terms formerly used, such as silver solder, hard solder, gold, solder, and brazing alloy [1] [2].

An aluminum-silicon brazing filler metals have been used for making brazed assemblies that can be generally exposed to nonstop provision temperatures up and around to 150°C. Minor-period operative temperatures at 205°C may be allowable, dependent on the operational environment. However, brazing alloys or welding rods containing 10-13% silicon cannot readily be made other than as extruded or cast rods due to their poor working properties at normal temperatures. Greater ductility and ease of fabrication are obtainable, though with higher melting point, by materials containing 5% or 7.5% of silicon, with 1% of zinc sometimes being added [3].

The aim of this work is to evaluate the best and optimum filler metals as clearance joint to give a high-quality joint according to mechanical properties with changing the clearance between adjacent base metal surfaces by two different filler metals with different silicon content. Also show the effect of the brazing time effect on the brazing joint strength. Finally study the microstructure cross section and morphology of the fractured surface in joint after shear tensile test.

2. EXPERIMENTAL WORK

2-1 MATERIALS USED

For metallurgical analysis, inclined and cylindrical joints are used, where all base metals used is a commercially pure aluminum (1100) with a chemical composition showed in Table (1) as tested in Central organization for standardization and quality control. Two types of aluminum-silicon filler metals selected, (Al-5%Si) or called E4043 supplied from Harris product group used as a rod with 3.2mm in diameter and the (Al-12%Si) was sampled from casted alloy to strips with 2x3mm cross sections.

Table (1): Base and filler metal aluminum alloys used in the study.

Alloy type	Chemical composition%								Al
	Si	Fe	Cu	Mn	Mg	Zn	Cr	Ni	
Al-1100	0.182	0.619	0.034	0.01	0.007	0.001	0.003	0.003	Rem
Al+5%Si	5.00	0.20	0.00	0.02	0.00	0.05	0.00	0.00	Rem
Al+12%Si	11.63	0.872	0.88	0.24	0.153	0.51	0.013	0.03	Rem

2-2 BRAZING PROCESS

Inclined specimen designed to make the clearance various by using two types' fillers metals with its length to facilities microstructure examination along different clearances values at the same test, while the cylindrical design useful to indicate large clearance effect and the maximum distance that filler metal can wet. Figure (1) showed a represented design for the joints combined of two parts, a rectangular aluminum plates with dimensions of (30x30x5 and 15x30x5mm) for inclined joint and (15x30x5 and sectioned part of a cylindrical shaft of 50mm in diameter and 5mm in thickness.

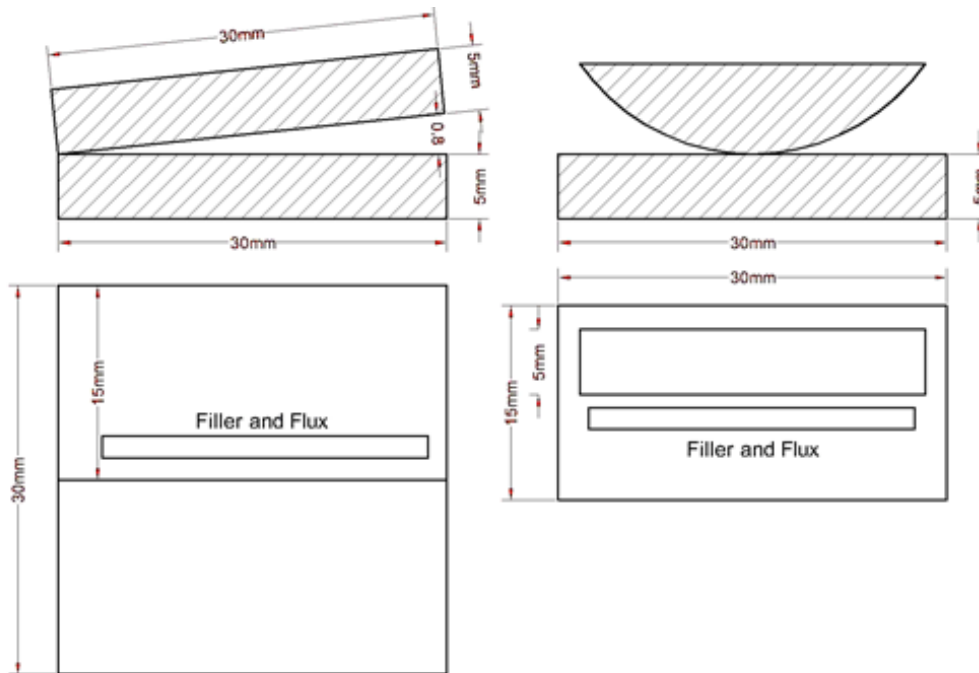

Figure (1): Design of inclined and cylindrical specimens of variable clearance.

2-3 FLUX USED

The flux used was [Al-Braze EC. 1070] product from HARRIS Company with a chemical composition explained in Table (2).

The flux used is compounds of fluorides and chlorides salt mixtures as shown in table (2). Adding flux to joint was done by mixing it with water as a paste then drops a small quantity gently beside the joint clearance. After covering the joint by the flux paste, the filler alloy rod placed parallel and attached to the joint.

Table (2): Composition and information on ingredients of AL-Brazing of the 1070 flux.

Components	W%
Lithium chloride	Major content
Zinc fluoride	< 5
Potassium fluoro aluminate	< 4
Zinc chloride	< 0.01
Composition comments	All concentrations are in percentage, by weight unless the ingredient is a gas. Gas concentrations are in volume percentage.

After completing the flux and filler preparing on joint the assembly placed gently inside the vertical furnace chamber as shown in figure (2), and the cover is closed.



Figure (2): Assembles specimens during brazing cycle in vertical furnace.

The furnace temperature set to 100°C for 10 minutes to evaporate the water from flux slowly preventing boiling and then it was set to 650°C for 5%Si filler and 600°C for 12%Si filler. The two-brazing temperature is founded by projection of silicon concentration in phase equilibrium diagram shown in figure (14) also the brazing temperature founded experimentally by watching the process periodically until the filler is melted during brazing process to avoid base metal during process, where the 5%Si alloy estimated melting temperature is near to base metal melting temperature. The brazing time was varied from (30 to 120) minute.

The environment in furnace during brazing cycle was air for all experiments and there is no need to use controlled atmosphere as Argon or helium because the flux serves as oxide removal and cleaning.

Tensile shear test samples prepared as lap joints by putting two aluminum plates (80x20x5) mm and overlapped 5mm to achieve the shear area of 100 mm². The filler alloys and flux prepared in the same procedure of the microstructural varied clearance samples.

After completing the brazing cycle all samples extracted from furnace and cooled by tap water to remove flux immediately while the samples hot. Samples sliced normally to brazing line as shown in figure (3), then samples sliced face grinded using different emery papers of silicon carbide grades varied from (320 to 200) PPI grades. Polishing was performed with diamond paste of 0.3 μm grain size on a polishing wheel covered with polishing cloth. Etching was done by immersion for 10 seconds in solution of 1% of hydrofluoric acid in distilled water.

After etching, the specimens were washed by tap water and finally by distilled water. Specimen preparations were done according to the ASM Metals Handbook [4].

Seven inclined samples were brazed; two of them by using 5%Si filler alloy and the rest by using 12%Si filler alloy. For shear tensile samples the 5%Si filler alloy all specimens failed from the base metal section and the joint stay without failure which indicated that the joint is stronger than the base metal. Table (3) represent number of experiments done with different holding time in a brazing temperature for two filler alloys.

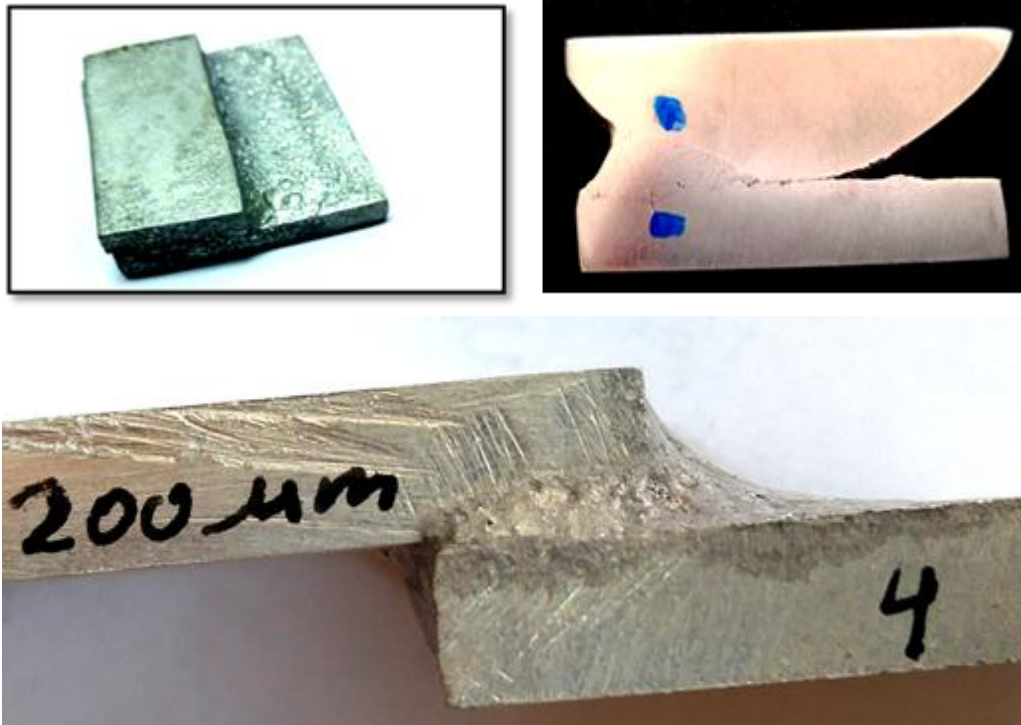

Figure (3): Brazed joints (Right) Cross section for cylindrical joint (Left) inclined joint (down) wetting angle after inclination for tensile test joint.

Table (3): Experiments parameters for brazing inclined samples.

No.	Filler Metal	Specimen Design	T (Minute)	T (C ⁰)	Maximum Clearance (μm)
1-	Al+5%Si	Inclined	30	650	800
2-	Al+5%Si	Inclined	60	650	800
3-	Al+12%Si	Inclined	30	600	800
4-	Al+12%Si	Inclined	60	600	800
5-	AL+12%Si	Inclined	90	600	700
6-	AL+12%Si	Inclined	120	600	800
7-	Al+12%Si	Inclined	150	600	800

2-4 THERMAL CYCLE

Brazing aluminum joint process was done by applying heat in an electrical furnace by using clearance (100,200,300,400) μm to inspect narrow and wide clearance effect metallurgically and mechanical proprieties of the brazed joints. Thermal cycle was applied at different temperatures and diffusion time. Brazing temperature was 600 °C for 12%Si and 650 °C for 5%Si and the brazing time were 30, 60, 90, 120 and 150 minutes respectively as explained in Figure (4).

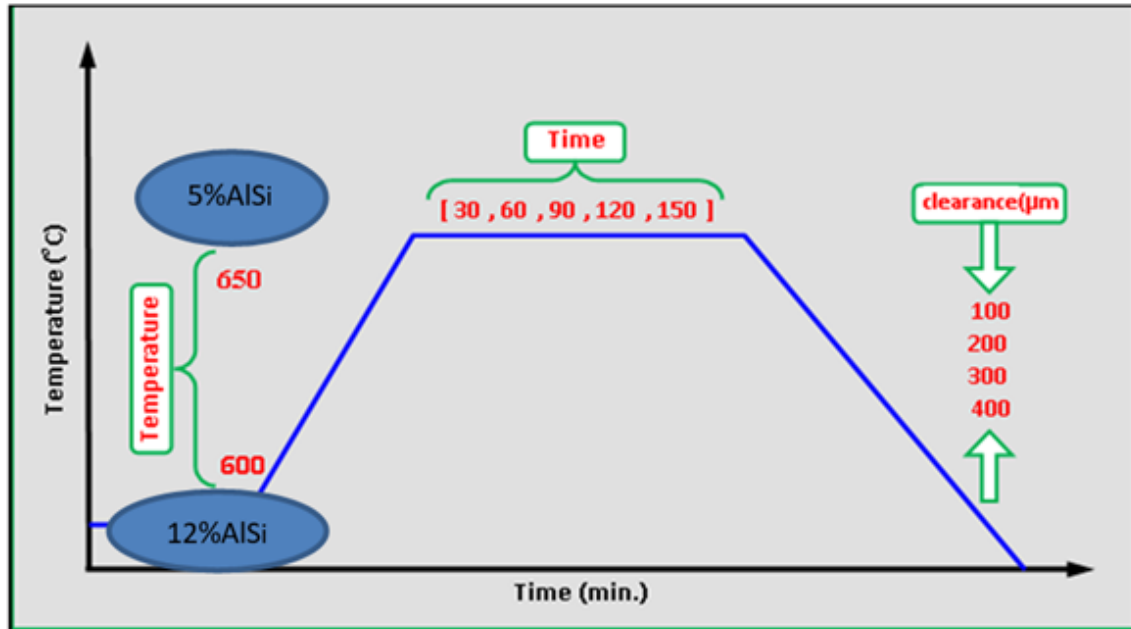

Figure (4) Thermal cycles for the brazed specimens.

3. RESULTS AND DISCUSSION

The results discuss the effect of two type filler metals and clearance on the solubility between the filler and the base metal also study the resulted microstructure for the joints, tensile shear strength, using scanning electron microscopy to determine the phases, micro-hardness and X-ray analysis of the brazed joints. The diffusion calculations idea is based on areas percentage of eutectic and solid solution phases before and after brazing process and the calculations applied on the 12%Si filler metal where the filler metal microstructure is 100% eutectic structure and any decreasing in this structure across the joint meaning more diffusion between liquid filler alloy and solid base metal. After completing the brazing joint the clearance cannot measured directly because of diffusion through grain boundaries between solid base metal and liquid filler alloy. So, clearance can be founded for any location across the joint section by multiplying the sin of inclination angle by the distance from the attached points or can be called the root of the angle where the angle was (0.7638°) derived by dividing the maximum clearance (0.4mm) on the joint length (30mm) which represent the tangent value of this angle.

3.1. MICROSTRUCTURAL ANALYSIS

To calculate the diffusion rate experimentally for joints with variable clearance and brazing time, a numerical equation of each case obtained using **GraphPad Prism 6** software. The cross joints areas analyzed for remaining phases using **ImageJ** software's. The first filler alloy of Al+12%Si microstructure before brazing consist of eutectic (Al-Si) with a grain size about $225 \mu\text{m}$. While the 5%Si filler alloy contains a eutectic structure of silicon-aluminum percentage of 40% according to the level rule in the equilibrium transformation diagram of (Al-Si) [5].

The microstructure of joints obtained by optical microscope images and analyzed using **ImageJ** software by converting the images to a binary color where the program count the phases depending on the white and black pixels as it seen in figure (5) where the black areas representing the eutectic structure and the white pixels represent the solid-solution phase. Analyzing by ImageJ software begin by converting 24bit

colored images to 8bit gray image then converting it to binary (Black and White) image as shown in the right side of figure (5).

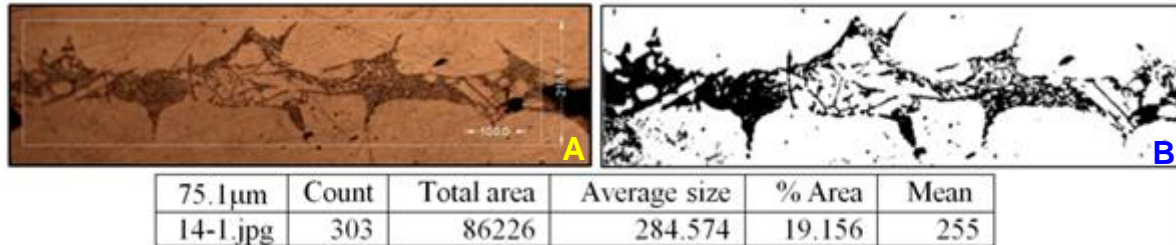

Figure (5): A- Optical microstructure for the brazed joint section. B- Binary color ImageJ® software image for diffusion rate calculations.

3.2. FRACTOGRAPHIC ANALYSIS

During examination of diffusion brazing specimens of 12%Si filler alloy by tensile-shear test, the fracture takes place at the Aluminum-Silicon interface as shown in Figure (6) where the right image shows flaked separation and left image shows silicon -aluminum phases which is the dark regions of 38% of silicon content and the bright regions representing the Aluminum-24%Silicon-18%Iron phase, the fracture mode is brittle -ductile type as shown in Figure (7) where there is elongation for the flakes and finally separation occurs also there are some crack propagations as shown in Figure (6).

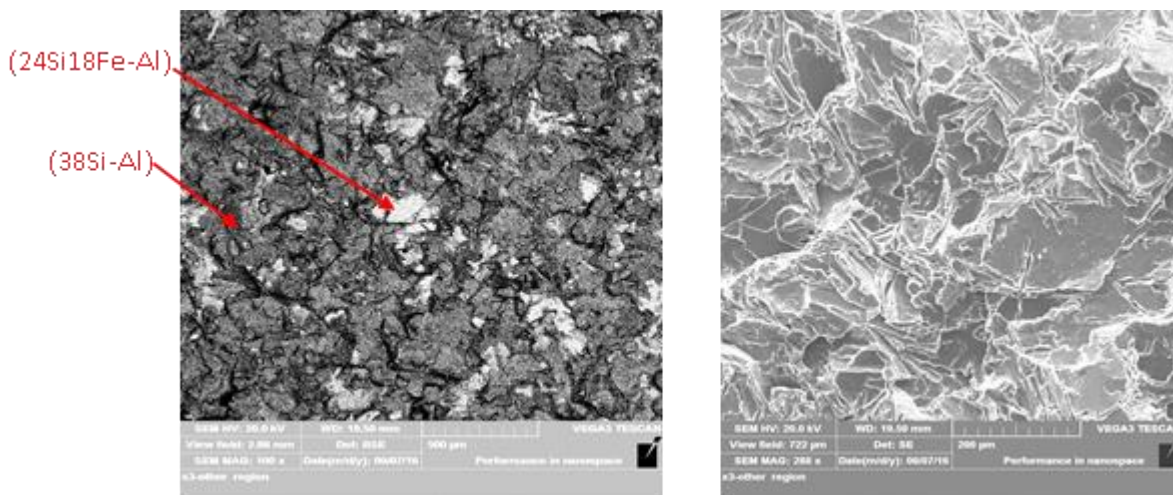

Figure (6): Fracture surface of the tensile-shear test specimens. Right image represents SEM topography and left image represents BSE image showing elemental distribution.

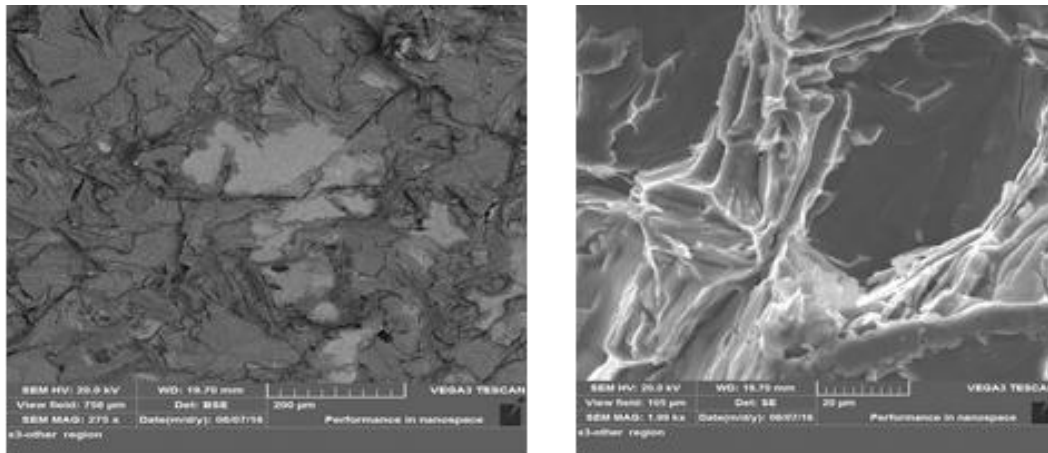

Figure (7): Fracture mode for tensile-shear test specimens of 12% Si alloy.

Fracture analysis of brazing joints using 5%Si alloy is not investigated because the failure occurs in the base metal section instead on the joint which indicates that the joint mechanical properties are greater than those of the base metal.

3.3. SHEAR TEST RESULTS (TENSILE SHEAR TEST)

Table (4) shows the effect of different values of brazing joint clearance on the resulting tensile shear strength for filler of 12%Si and Table (5) shows the effect of joint clearance on shear strength for 5%Si filler metal.

Table (4): Tensile shear results of filler alloy of 12%Si at different clearance values.

Clearance (12%Si+Al) (μm)	Load (N)	Joint Area (mm^2)	Fracture Shear Strength (MPa)
100	8550	160	53.43
200	8860	140	63.2
300	7400	100	74.00
400	6760	140	48.28

All tensile shear specimens tested by INSTRON tensile and compression press 1195 Machine in strength of material laboratory. The tensile shear test specimens dimensions was 80x20x5 mm as showed in Figure (8) and the specimens clearance adjusted using brazing foil layers made of BNi2 with thickness of 50 μm . This foil melting temperature is above 1000°C and the base metal of it is the Nickel used to braze stainless steel and super alloys, therefore it will not react with aluminum brazing process and maintain the distance between adjusted two Aluminum specimens.

Table (5): Tensile shear results of filler alloy of 5%Si at different clearance values.

Clearance (5%Si+Al) (μm)	Load (N)	Joint Area (mm^2)	Fracture Shear Strength (MPa)
100	5760	100	57.6
200	10240	100	102.0
300	7320	100	73.20
400	3000	100	30.00

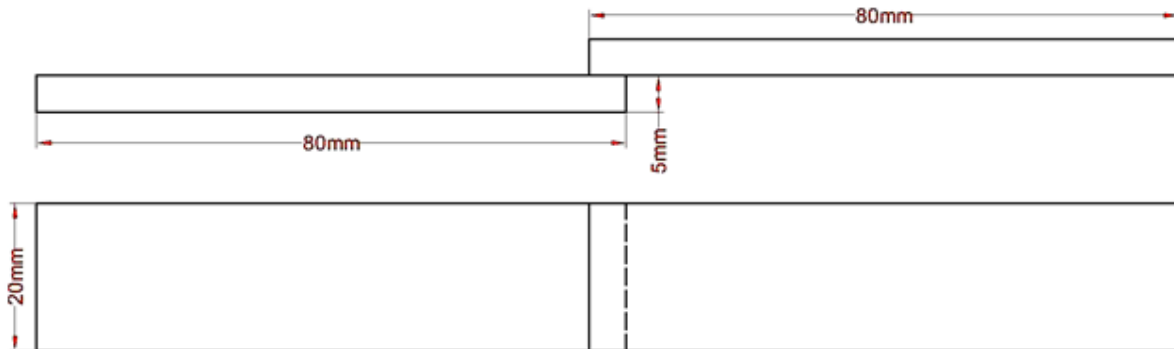

Figure (8): Dimensions of shear tensile test specimens

From Figure (9) and Figure (10) it can have concluded that the optimum clearance values give higher strength is 300 μm for filler alloy of 12%Si content with shear strength of 74MPa and 200 μm for filler alloy of 5%Si content with 102MPa.

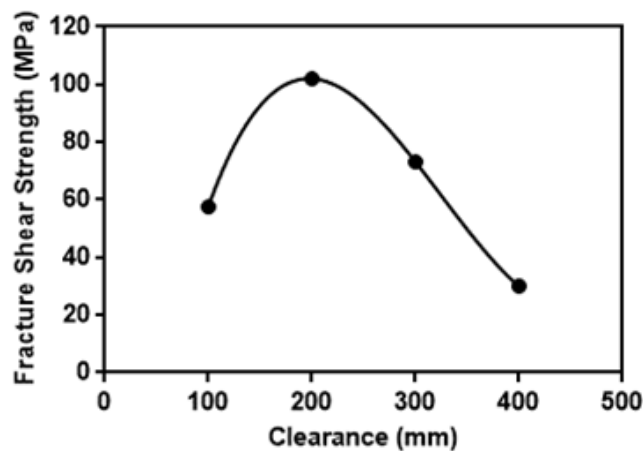

Figure (9): Effect of clearance on shear strength for 12% Si filler metal.

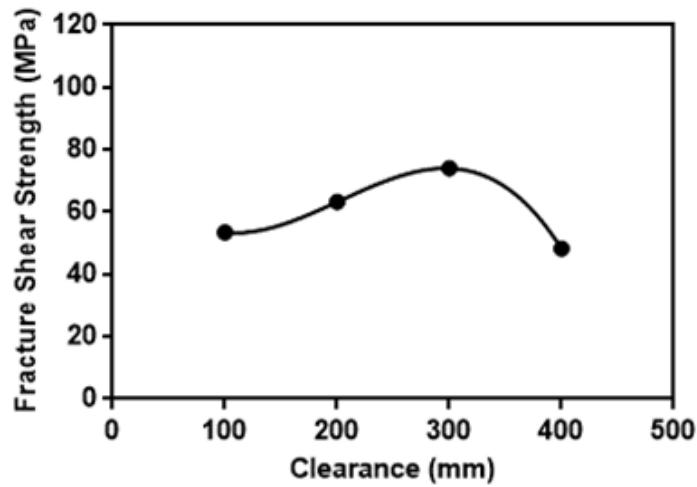

Figure (10): Effect of clearance on shear strength for 5% Si filler metal

To achieve joints strength compared to the brazed joints the aluminum alloy type (1100) was tested by tensile test and the resulting value was 104 MPa for the yield strength and 120MPa for the ultimate tensile strength as shown in Table (6) below. The results of tensile test for the brazed joints limited to the breaking point which indicating the joint strength.

Table (6): Tensile strength of the 1100 Al brazed joint

test specimens	Ultimate Tensile (MPa)	Yield Strength (MPa)	Elongation %
Al-Alloy 1100	120	104	17.00

3.3.1. Vickers Hardness Test

Micro hardness tests of all the samples achieved by micro hardness device shown in figure (11) and the applied load during the testing fixed on 500 g, with a dwell time of 15 sec. It has a square-base diamond pyramid indenter. The Vickers hardness number (VH) is calculated from the following equation [1]:

$$Hv = 1.8544 \times \frac{P}{(d_{av})^2} \dots\dots\dots (1)$$

where:-

- P: Applied load (kg)
- d_{av} : Average length of diagonals (mm)
- Hv: Vickers hardness (kg /mm²)

The hardness distribution along the brazed joints at temperatures of 600C for filler 12%Si is shown in Figure (12) and 650°C to filler 5% Si shown in Figure (12).



Figure (11): Digital micro-vickers hardness tester machine.

Figure (12) shows the micro hardness distribution along brazed joint using optical microscope denoting each hardness point with its value while Figure (13) shows the projection of the hardness values on scanning electron image. The hardness of the center of the brazing joint is higher than the hardness of the base metal for each filler used but the filler of 12%Si alloy gives higher hardness value than the filler 5%Si alloy which indicates more brittle joint due to the high silicon content of the filler brazing alloy which produces intermetallic compounds of Al-Si and Al-Fe as mentioned in X-Ray diffraction analysis. This affects the strength of the joint where the 5%Si filler joint is more ductile than 12%Si alloy joint.

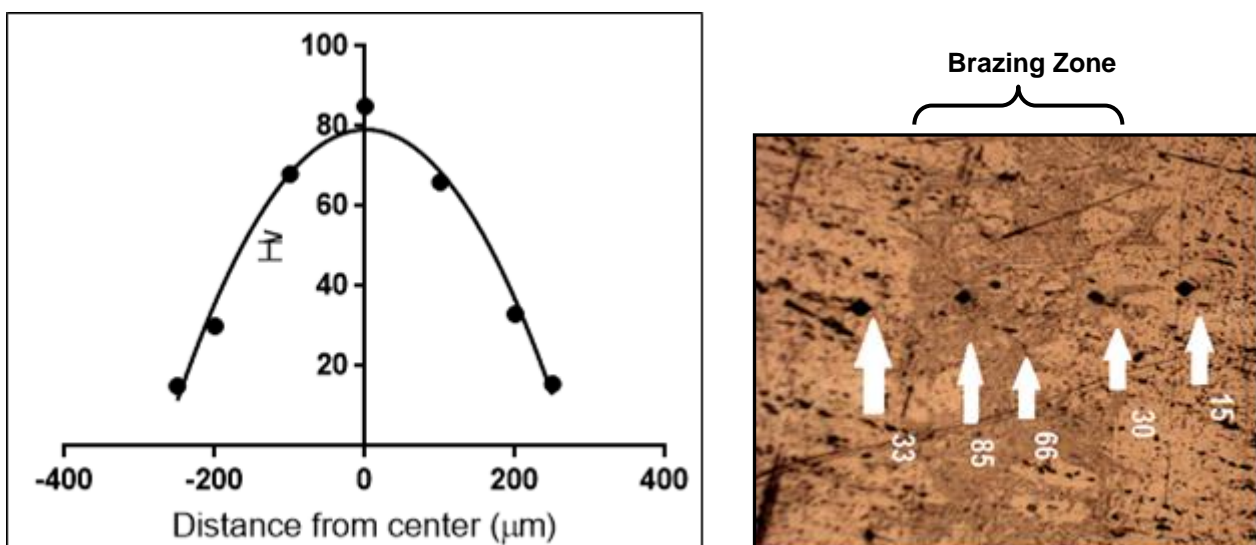

Figure (12): The variation of hardness along the brazing joint of Al-alloys 1100 and with filler metal of 12%Si content.

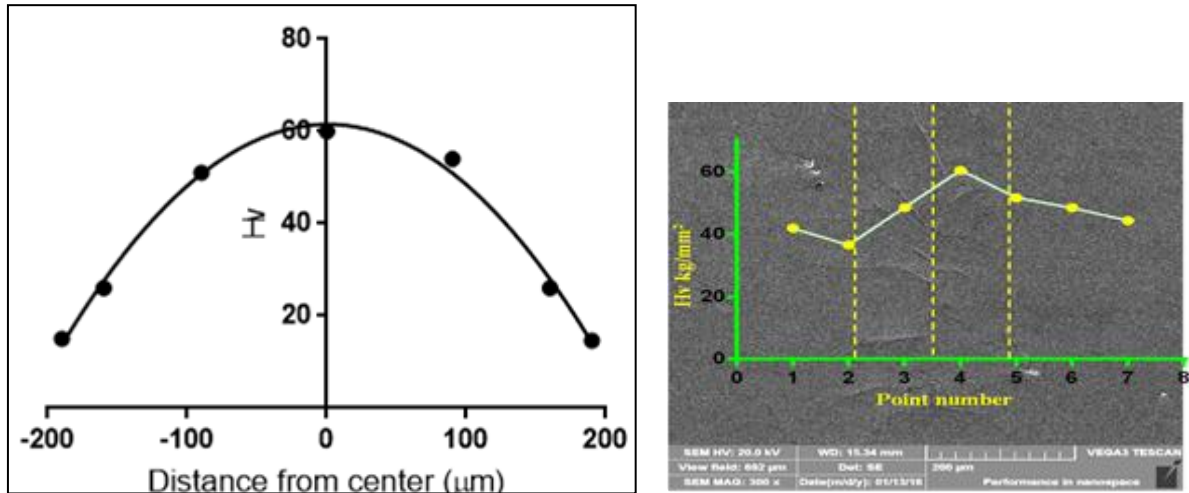
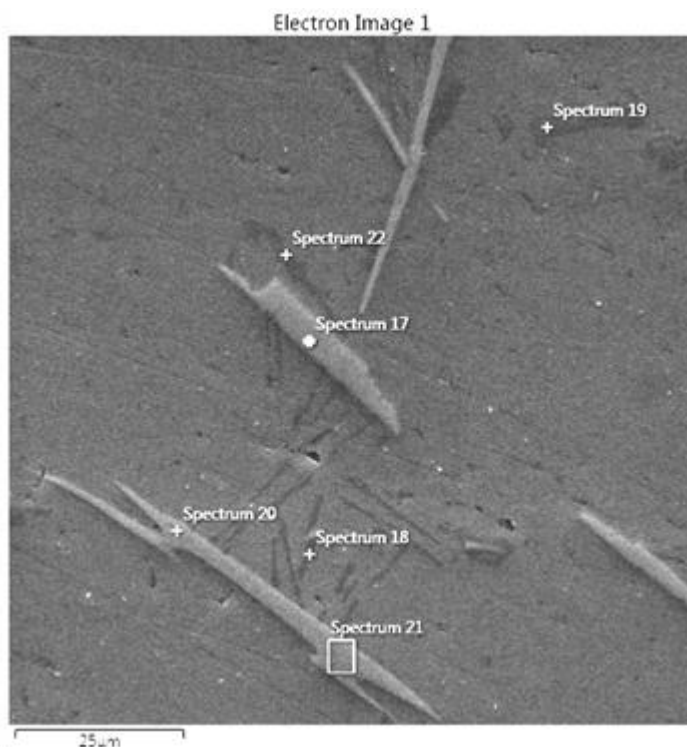

Figure (13): The variation of hardness along the brazing joint of Al- alloys 1100 with filler metal Al+5%Si.

The joints of 5%Si filler alloy cannot be analyzed by the software due to high diffusion rate and low phases of silicon concentration in joint core on the contrary of 12%Si filler alloy joints. As well as the same condition applies to shear tensile test, where the 5%Si filler alloy joints frailer occur in base metal instead of the joint.



No.	Elements (wt%)				
	AL	Si	Fe	Cu	Mn
17	66.8	15.7	17.5	---	---
18	49.1	50.9	---	---	---
20	56.7	12.5	30.7	---	---
21	61.5	15.5	23.0	---	---

Figure (14): Point chemical analysis for 5% Si filler alloy joint core with 30minute of brazing holding time at 650°C.

Figure (14) represent the microstructural analysis and point chemical analysis using SEM attached with EDS detector to the brazing region of 5%Si filler alloy. There are two phases shown clearly. The first phase represents the points 17, 20 and 21 which located in θ region in figure (15) as a small blue triangle and it appear as bright needles representing the major phase and the second phase appear like dark fine needles as minor phase where its chemical composition in points 18 and 22 and when these two points projected in ternary diagram it located in diamond silicon phase.

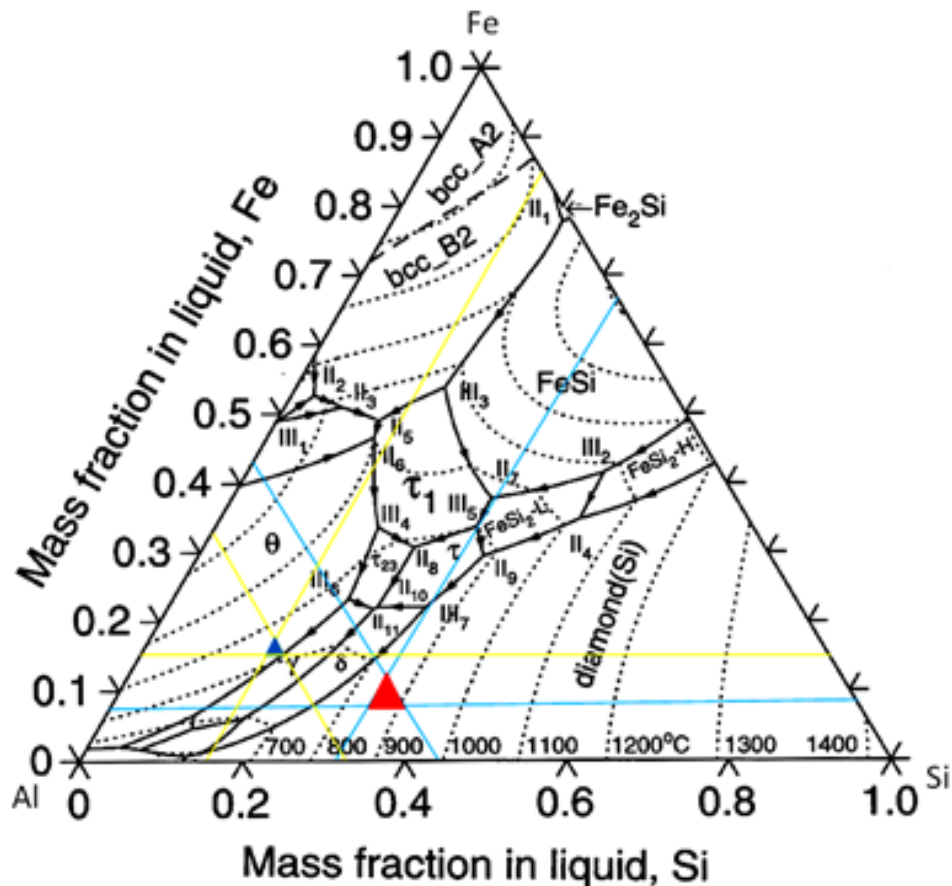

Figure (15): Ternary phase diagram for Al-Si-Fe and the phases locations for the analyzed points [6].

Figure (17) represent EDS points analysis for the SEM image for 12%Si brazing filler metal. There are three main phases. Points 17 and 19 represents θ phase of aluminum-silicon when projected on ternary diagram shown in figure (15) where this phase shaped as needle like and the diamond silicon irregular shape phase represents in points 20 and 22. Point 18 showing an aluminum 60% and copper composition which make θ phase on Al-Cu equilibrium phase diagram in figure (16).

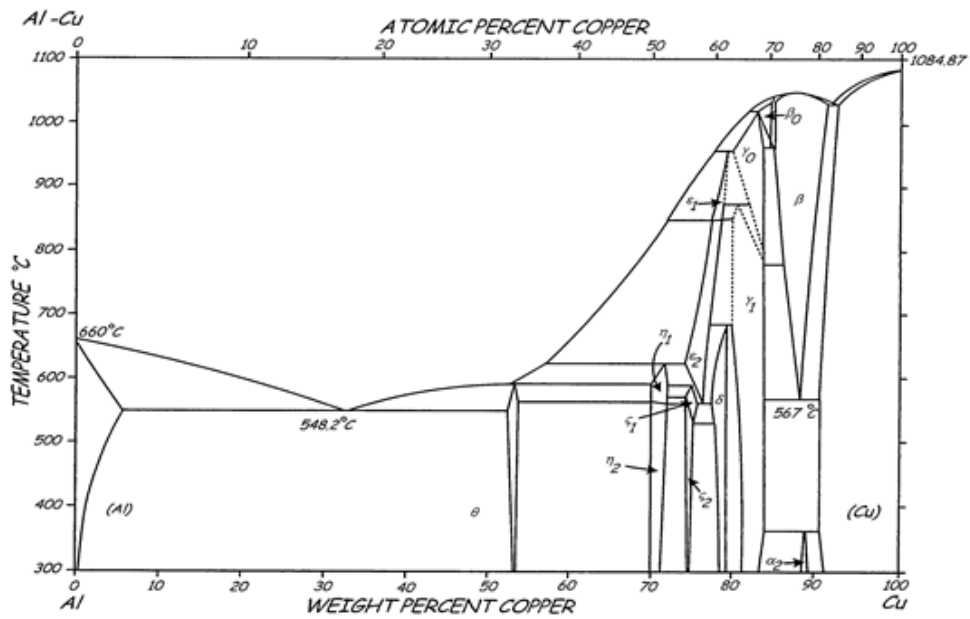
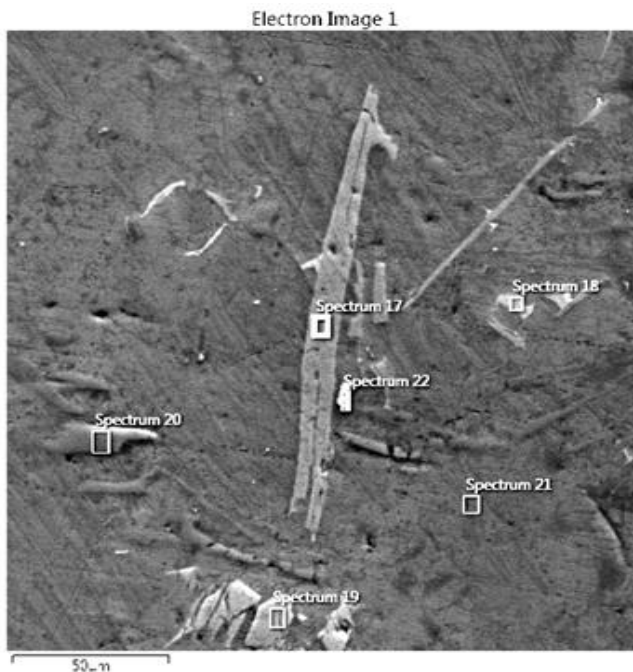

Figure (16): Al-Cu equilibrium phase diagrams [7]



No.	Elements (wt%)				
	AL	Si	Fe	Cu	Mn
17	56.3	17.2	24.0	---	2.5
18	60.0	---	---	40.0	---
19	66.6	8.8	18.2	---	6.5
20	37.9	61.3	---	---	---
21	97.3	2.1	---	---	---
22	75.2	21.2	---	---	---

Figure (17): Point chemical analysis for 12%Si filler alloy joint core with 30minute of brazing holding time at 600°C.



CONCLUSIONS:

The following points can be concluded from the present work:

1. The two filler metals 5%Si and 12%Si Aluminum alloys completely spread and fill the joint at the first minutes of liquation.
2. The two filler alloys 5%Si and 12%Si Aluminum alloys had equivalent tensile strength of 176 and 128MPa respectively which is stronger than the mechanical properties of the base metal ultimate tensile strength (120 MPa).
3. The formation of (AlSi, AlSiFe and eutectic phase) are responsible for joining process and gives the strength to the joint.
4. 5% silicon content filler metal shows better mechanical and metallurgical properties where the shear tensile strength and spreading across the joint is better than 12% silicon content filler metal.

REFERENCES:

1. **William. D. Callister**, "*Fundamental of Materials Science and Engineering an Integrated Approach*", John Willey& Sons, (2008)
2. **Howar.B.**, "*ModrenWeldingTechnology*", 5th _Edition, prentice, prentice_Hall, 2002
3. **Practice, Philip M.Roberts**, "*industrial Brazing*", /Hardcover/ CRC/press, December 2003
4. **David L. Olson**, "*Welding and Brazing and Soldering*", "*Metals Hand Book*", Volume Six, , 9th Edition. ASM, 2004
5. **Hugh Baker**, "*ASM Metals Handbook, Vol 03 alloy phase diagrams*", Page 2-52, 2004
6. **Martin C.J. Markera, Barbara Skolyszewska- Kühbergera**, "*Phase equilibria and structural investigations in the system Al-Fe-Si*", *Intermetallics Volume 19, Issue 12, Pages 1919–1929*, Copyright Elsevier B.V © 2016
7. **T. B. Massalski, Hiroaki Okamoto**, "*Alloy phase Diagrams-Binary Alloy Phase Diagrams*", ASM, vol.3,2-44, 1985.
8. **Patricia B. Roy, Fiona M. O'Connell**, "*Vickers Microindentation Hardness Testing of Brazed Joints in Aluminum*", *Loyola University Maryland* 21210, pp(1 to 20), 2013