

Android Based Employee Absence and Leaving Application Information System

Baenil Huda¹

Information System, Faculty of Engineering and Computer Science
Universitas Buana Perjuangan
Karawang, Indonesia
baenil88@ubpkarawang.ac.id

Shofa Shofiah Hilabi²

Information System, Faculty of Engineering and Computer Science
Universitas Buana Perjuangan
Karawang, Indonesia
shofa.hilabi@ubpkarawang.ac.id

Maya Rahayuningsih³

Information System, Faculty of Engineering and Computer Science
Universitas Buana Perjuangan
Karawang, Indonesia
si16.mayarahayuningsih@mhs.ubpkarawang.ac.id



Abstract — Attendance in general is the recording of employee attendance and is one aspect of assessment in a company. The purposes of this study are finding out how employees can apply for leave and how to design and build an Android-based attendance system application. Data collection methods that used in this research include observation, interviews and literature study. The system development method that will be used is the System Development Life Cycle (SDLC) model of the Waterfall. With this system, employees and companies will be helped in the problem of absence and leave. The company will get accurate, fast and precise data in decision making.

Keywords: Attendance, Leave, Android, UML, Waterfall

Abstrak — Absensi secara umum merupakan pencatatan kehadiran karyawan dan termasuk salah satu aspek penilaian dalam suatu perusahaan. Tujuan dari penelitian ini yaitu pertama untuk mengetahui bagaimana karyawan dapat melakukan pengajuan cuti dan yang kedua yaitu untuk mengetahui bagaimana merancang dan membangun aplikasi sistem absensi berbasis android. Metode pengumpulan data yang akan digunakan pada penelitian ini yaitu diantaranya observasi, wawancara dan studi pustaka. Metode pengembangan sistem yang akan digunakan yaitu System Development Life Cycle (SDLC) model Air Terjun (waterfall). Dengan adanya sistem ini, karyawan dan perusahaan akan terbantu dalam masalah absen dan cuti serta perusahaan akan mendapatkan data yang akurat, cepat dan tepat dalam pengambilan keputusan.

Kata Kunci: Absensi, Cuti, Android, UML, Waterfall

I. INTRODUCTION

The development of technology as it increases from year to year is now very fast, we can get various technological advances easily, especially in information technology. Utilizing information technology is a must for companies so that they are not left behind by the times, so, naturally, today many companies are competing to update new systems and

technologies because to improve their business, especially in fields that are closely related to information technology.

One of them is the employee attendance system and leave requests, the company must carry out this process properly, to make it easier to make decisions, the company needs accurate information without having to go through the manual recording which must be done repeatedly because the manual process takes a long time so it is not effective. . Previously, the company only had physical documents but over the years the company-owned data also increased. This is one of the reasons companies use information technology in managing data such as attendance and leave data. Attendance systems at companies start from using paper, fingerprints, magnetic cards to only using smartphones. The number of smartphone users currently allows some companies to update their Android-based attendance and leave application systems [1] because it is more effective and efficient without having to queue to do absences and to reduce the buildup of leave application files in general.

Online attendance is recording attendance with a system that is connected to a real-time database [2]. Employees can take attendance via smartphone anywhere according to their entry and return hours as long as the employee is still in the company environment. This requires a Local Area Network (LAN) which is only within the company environment so that employees cannot do attendance outside the company environment because the network coverage that is set up only covers company areas. Besides being able to do attendance, this system can also apply for leave. The concept of an attendance system application that will be made is to make it easier for employees and companies in making attendance and filing leave and in making reports related to company data [3].

Based on the above background, the writer tries to analyze and study the attendance system and leave submission which I will write in a final report entitled "Application of Employee Attendance Information System and Android-Based Leave Submission".

II. METHODS

In this study, researchers researched several stages, namely the first to collect data, design systems, develop systems, test, and write a final report. The stages are as follows [4]:

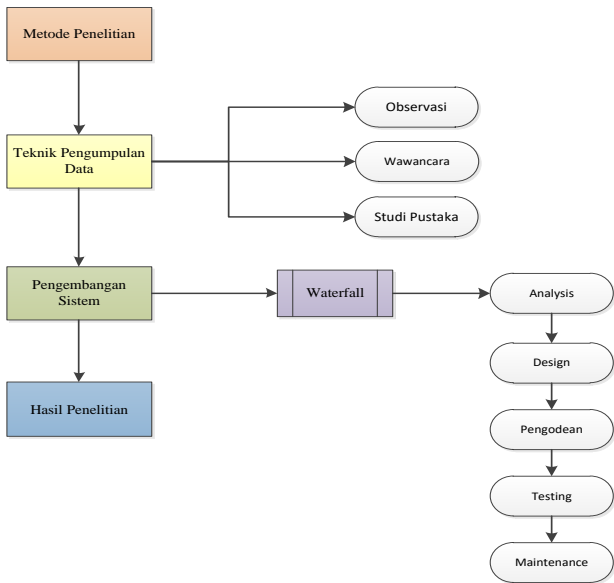

Figure 1. Research flowchart

Based on the picture above, the research stages are carried out starting from collecting data about the object to be studied, then continuing with designing the system to be made using the Unified Modeling Language (UML) after that developing the system using the Waterfall model [5], then proceeding to test a system to check functionality, if all stages have been completed then the process of writing a report from the research results.

Systems Development Method

The system development method used in this study is the waterfall methodology [6].

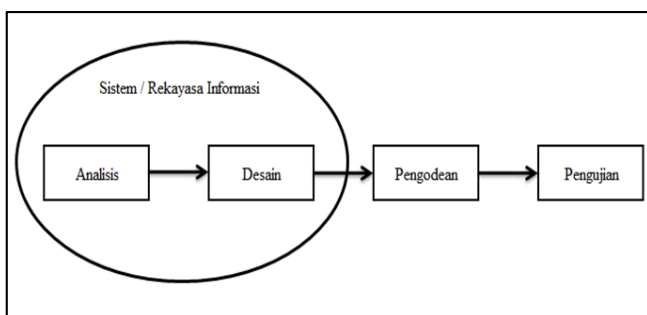

Figure 2. Stages of the waterfall methodology

A. Analysis

The process of collecting requirements is carried out intensively to specify software requirements so that it is easy to understand what kind of software is needed by the user [7]. In this study, the analysis was carried out through the method of observation at PT. XYZ regarding attendance and leave as well as conducting direct interviews with several employees of PT. XYZ to determine the shortcomings of the ongoing system

and researchers dig up data from several journals, theories, and electronic documents that can support the research process [8].

B. Design

A multi-step process that focuses on the design of a software program including data structures, interface representation software architectures, and coding procedures. In this study, researchers designed a system using UML (Unified Modeling Language) and for user interface design using the Pencil application [9].

Making Program Code

The design must be translated into a software program. The result of this stage is a computer program by the designs that have been made at the design stage. In making program code (coding) in this study using Android Studio tools, with the Flutter Framework and the Dart programming language and Visual Studio Code as a programming language code editor.

C. Making Program Code

The design must be translated into a software program. The result of this stage is a computer program by the designs that have been made at the design stage. In making program code (coding) in this study using Android Studio tools, with the Flutter Framework and the Dart programming language and Visual Studio Code as a programming language code editor.

D. Maintenance (maintenance),

The maintenance stage can repeat the development process starting from specification analysis for changes to existing software, but not for creating new software. Maintenance includes correction of unknown errors in the previous process, improvement of implementation, development of the system unit, and program maintenance.

III. RESULTS AND DISCUSSION

In making program code (coding) in this study using Android Studio tools, with the Flutter Framework and the Dart programming language and Visual Studio Code as a programming language code editor.

Before entering the coding stage, make a design and workflow of the proposed system first. The following are some of the stages in System And Software Design [10]:

1. Use case diagram.

Use case diagrams are pictures of some or all actors and use cases to recognize their interactions in a system

a. Use case diagram of employee attendance system

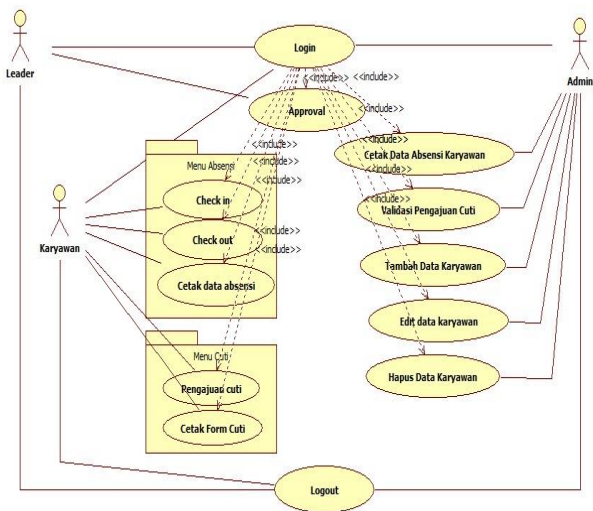
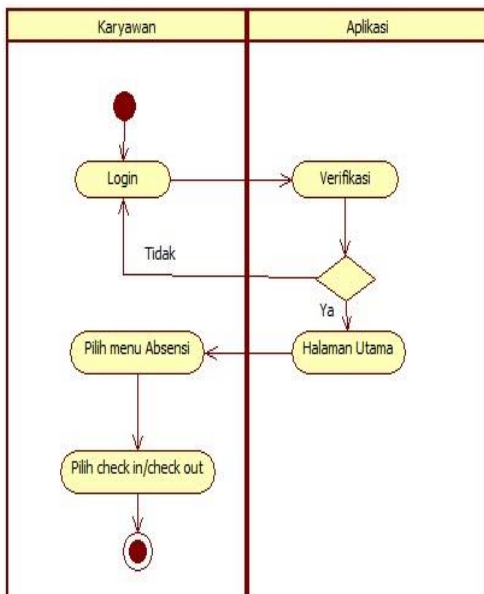

Figure 1. Usecase diagram of employee attendance system

2. Activity diagram

Activity diagrams describe a series of flow from activities, used for other activities such as use cases or interactions.

a. Employee attendance activity diagram



Gambar 1. Activity diagram absensi karyawan

To carry out the employee attendance process, you must first log in using the username and password that has been set by the admin for each employee, if the verification is successful it will go to the main page and if it fails, it will return to the login page. When you have successfully logged in, select the attendance menu then select check-in when entering or select check out when leaving.

b. Activity diagram for requesting leave

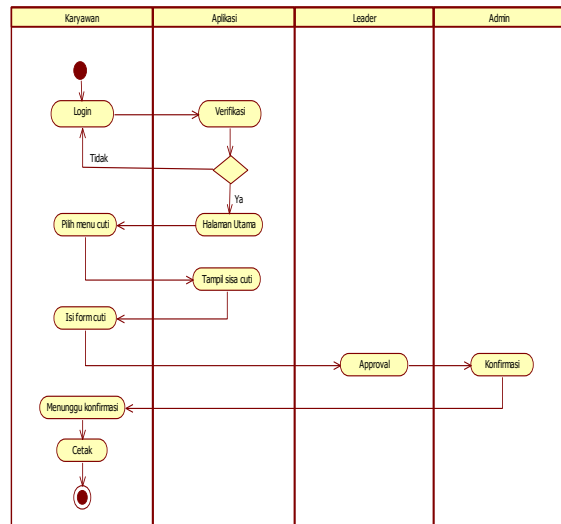

Figure 3. Activity diagram for requesting leave

that is, to apply for leave such as the activity above, the employee must first log in first, then if the login is successful, it will enter the main page, if it fails, the login will return to the login menu. When you have successfully logged in, select the left menu then see the remaining leave then fill in the leave submission form, after that the leader approves the leave submission, the admin confirms and the employee waits for confirmation from the admin whether the leave application is accepted or rejected by looking at the leave status in the leave history menu then print leave form.

3. Sequence diagram

Sequence diagrams describe the dynamic collaboration between some objects and to show a series of messages sent between objects as well as interactions between objects, something that occurs at a certain point in the system's execution.

a. Employee attendance sequence

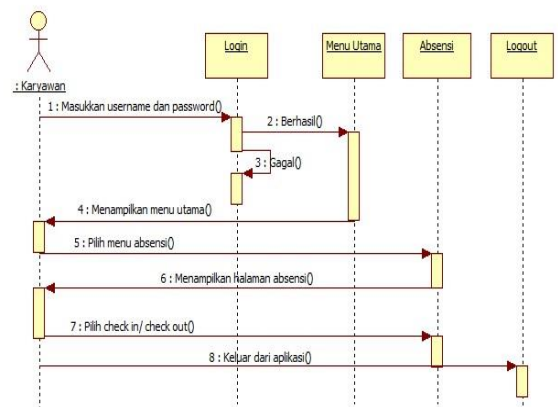

Figure 4. Sequence diagram of employee attendance

Employee attendance system, namely to enter the application, the employee must first enter a

username and password. If the login is successful, it will enter the main page, if it fails, it will return to the login page. When you have successfully logged in, select the attendance menu, then the system will display an attendance page after that select check-in when entering or check out when exiting and select log out to exit the application.

b. Sequence diagram for filing leave

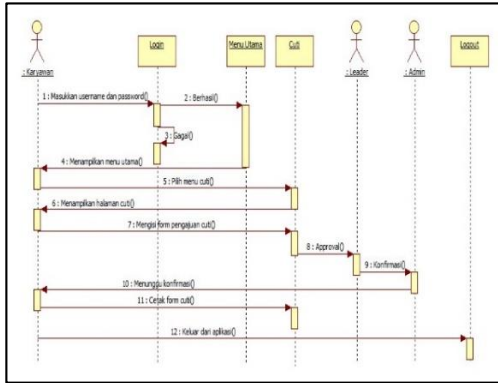

Figure 5. Sequence diagram for filing leave

To apply for leave, employees must first log in by entering the username and password that has been set by the admin for each employee, if the employee successfully logs in, he will enter the main page, and if it fails, it will return to the login page. When login is successful, select the left menu then the system will display the left page then see the remaining leave then fill in the leave application form and it is approved by the leader after that wait for confirmation from the admin whether the application is accepted or rejected via the application then print the leave form that has been received. Select logout to exit the application.

4. Class diagram

Class diagrams are used to explain the system structure in terms of defining the classes that will be made to build a system.

a. Class diagram of employee attendance system and leave application

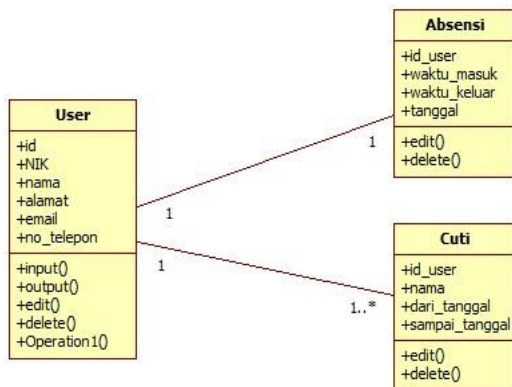

Figure 6. Class diagram of the employee attendance system and leave requests

Designing application and web pages for employee attendance and leave submission

Page design Interface design is an interface design that describes the display plan of the employee attendance system application to be built. Below is a view of several interface designs for mobile and web admin applications made using the Pencil application [11].



Figure 9. Design of employee attendance page

On this attendance design page, employees perform attendance by choosing check-in for entry and check-out on exit



Figure 10. Design of leave application page

On this leave design page, employees apply for leave only by filling in the leave form and then the leader will approve it

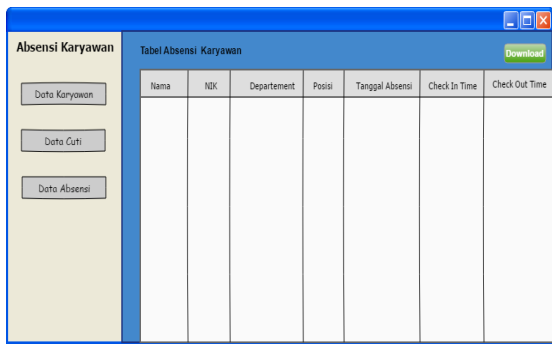

Figure 11. The design of the admin attendance page

On the attendance data admin web design page, the admin can view the attendance data of all employees and download it.

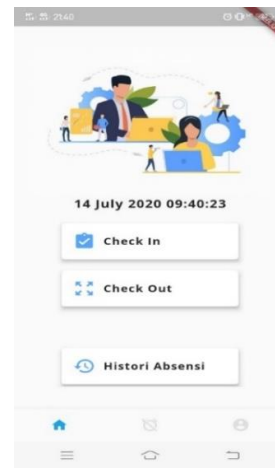

Figure 14. Implementation of employee attendance pages

employee attendance page where employees only click check-in when entering or check out when leaving then the data will be stored in the database, and employees can view attendance history or can print it if needed [12].

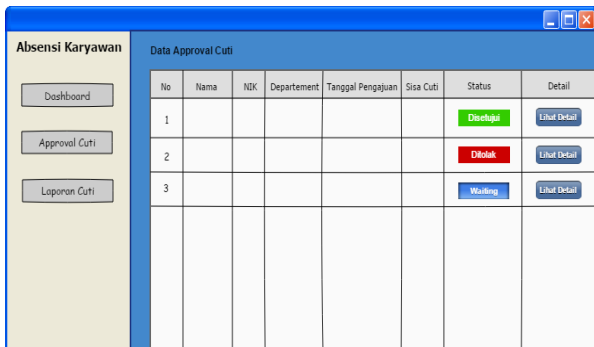

Figure 12. The design of the leave leader's approval page

On the leader's leave approval design page, the leader can approve the employee leave application, which will then be confirmed by the admin.



Figure 15. Implementation of leave application page

The leave application page is for employees to apply for leave by simply filling in the form and entering the date from and to when the employee will apply and employees must also fill in family contacts who can be contacted during leave [13].

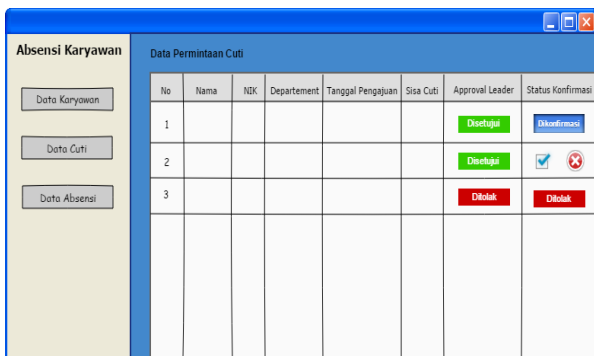

Figure 13. The design of the admin leave confirmation page

On this web admin design page, the admin can confirm submission of employee leave after leader approval. Implementation of employee attendance and leave application web pages

The results of the interface design have been built in the first stage, then the next stage is implementing or realizing the system design into the actual application. Below are some of the display implementations of the mobile application and the web admin for employee attendance systems.

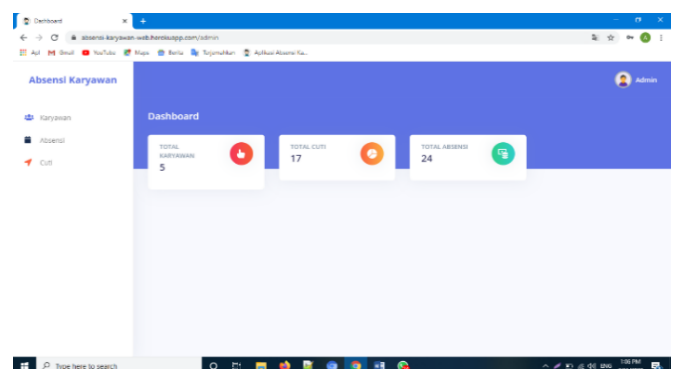

Figure 16. Implementation of the main admin page

Attendance system dashboard page which is the main web page and can only be accessed by admin [14], on that page can be seen the number of employees, attendance, and leave requests.

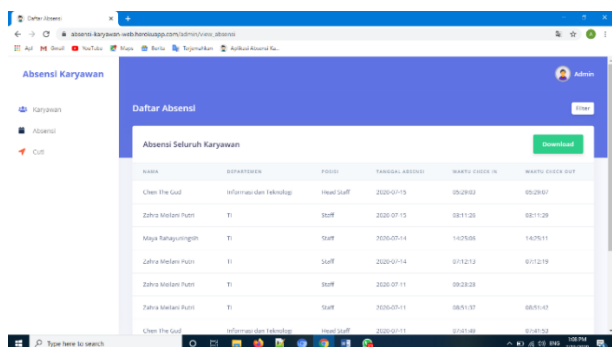

Figure 17. Implementation of admin attendance page

attendance page where admin can see the attendance data of all employees and print it to make a report that will be submitted to superiors.

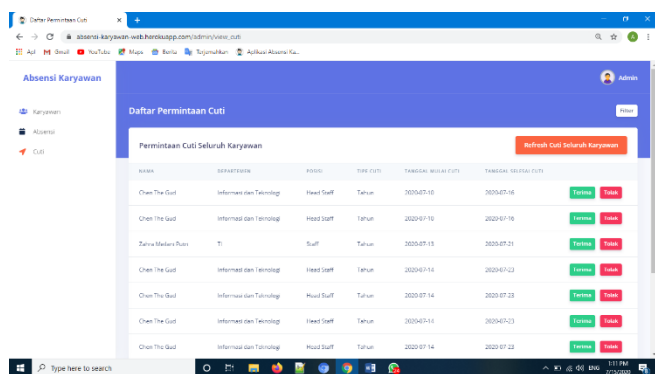

Figure 18. Implementation of admin leave confirmation page

Leave confirmation page on the admin web where admin confirms employee to leave after the leader approves and the application will receive a notification if the leave request has been validated by the admin [15].

IV. CONCLUSION

Based on the results of the above discussion and observations, several conclusions can be drawn, namely:

1. Employees can do attendance without queuing using the online attendance application with the username and password that the admin has set for each employee.
2. Employees can apply for leave online by simply filling in the leave form through the application.

REFERENCES

[1] P. A. Sunarya, E. Febriyanto, And J. Januarini, "Aplikasi Mobile Absensi Karyawan Dan Pengajuan Cuti Berbasis Gps," *Ccit J.*, Vol. 12, No. 2, Pp. 241–247, 2019.

[2] R. A. Makhfuddin And N. Prabowo, "Aplikasi Absensi Menggunakan Metode Lock Gps Dengan Android Di Pln App Malang Basecamp Mojokerto,"

Issn, Vol. 5, No. 2, Pp. 55–63, 2015.

[3] Dhanta Dikutip Dari Sanjaya, "Aplikasi Berbasis Web," *Aplikasi Berbasis Web*. 2015.

[4] S. Mulyani, *Metode Analisis Dan Perancangan Sistem*. 2017.

[5] D. M. Shalahuddin, "Model Pengembangan Perangkat Lunak Menurut Rosa A. S. Dan M. Shalahuddin," *Model Pengemb. Perangkat Lunak*, 2014.

[6] S. S. Hilabi And . P., "Analisis Kepuasan Pengguna Terhadap Layanan Aplikasi Media Sosial Whatsapp Mobile Online," *Buana Ilmu*, Vol. 3, No. 1, Pp. 119–136, 2018.

[7] M. S. Rosa A.S, Rosa A.S, M. S. (2016). *Model Waterfall*. 2016. Bandung: *Informatika. Model Waterfall*. 2016.

[8] M. Y. Simargolang And W. A. Warsito, "Analisis Sistem Pengolahan Absensi Karyawan Pada Pt. Bakrie Sumatera Plantations Tbk Bunut," *J. Teknol. Inf.*, Vol. 1, No. 2, P. 114, 2018.

[9] Rosa A.S Dan M. Shalahudin, "Rekayasa Perangkat Lunak (Terstruktur & Berorientasi Objek)," *Politek. Negri Sriwij.*, 2011.

[10] Verdi Yasin, *Rekayasa Perangkat Lunak Berorientasi Objek*. 2011.

[11] Baenil Huda And Saepul Apriyanto, "Aplikasi Sistem Informasi Lowongan Pekerjaan Berbasis Android Dan Web Monitoring (Penelitian Dilakukan Di Kab. Karawang)," *Buana Ilmu*, 2019.

[12] S. N. Aisyah And K. A. Hafizd, "Aplikasi Absensi Karyawan Pt. Angkasa Pura I (Persero) Banjarmasin," *J. Sains Dan Inform.*, Vol. 3, No. 1, P. 7, 2017.

[13] A. Setiyanto, F. Samopa, And Alwi, "Pembuatan Sistem Informasi Cuti Pada Kantor Pelayanan Perbendaharaan Negara Dengan Menggunakan Php Dan Mysql," *Tek. Pomits*, Vol. 2, No. 2, Pp. 381–384, 2013.

[14] B. Huda, "Sistem Informasi Data Penduduk Berbasis Android Dan Web Monitoring Studi Kasus Pemerintah Kota Karawang (Penelitian Dilakukan Di Kab. Karawang)," *Buana Ilmu*, 2018.

[15] B. Priyatna, S.S Hilabi, N. Heryana, "Aplikasi Pengenalan Tarian Dan Lagu Tradisional Indonesia Berbasis Multimedia," *Systematic*, Vol. 1, No. 2, Pp. 89–98, 2019.