

## **Research and application of climate-responsive design of traditional vernacular houses in Chaoshan, China**

**Jinglei Li<sup>1</sup>, Zhaoji Wu<sup>1</sup>, Yufeng Zhang<sup>1</sup>**

*<sup>1</sup>State Key Laboratory of Subtropical Building Science, Department of Architecture, South China University of Technology, Guangzhou, China*

---

### **Abstract**

Chaoshan vernacular house is an important branch of Lingnan traditional houses in South China, with a long architectural history and excellent climate responsiveness to the hot-humid climate. The modern rural houses learn the traditional experiences mainly in the form but fail to inherit the climate-responsive design and wisdom of the traditional houses. This study took the widely distributed Xiashanhu houses in Chaoshan as the object, generated 128 Xiashanhu parametric models by combinations of various parameters on design factors of building, opening, shading, construction, and street layout, and investigated the climate-responsive design techniques by using the parametric methods. The results show that the hall width, room width, cornice height, orientation, and wall construction are the key climate-responsive design factors oriented towards thermal performance of Xiashanhu houses. The optimized designs are: the smaller hall width (4.05m, 4.32m, 4.59m), the smaller room width (2.7m, 2.97m, 3.24m), the larger cornice height (4.92m, 5.1m), the orientation ranged from 30° north by west to 30° north by east, and the brick and concrete wall. The rationality and validity were verified by applying the optimized climate-responsive designs to the re-construction of a new rural house. Compared to the original case, the thermal performance is significantly improved by 5.18-9.98%. A detailed discussion was also provided on considering the actual situation and needs of the modern buildings in the process of "using the past for the present." This study is believed to provide valuable references for the research and modern applications of climate-responsive designs of traditional vernacular houses. It also contributes to the preservation of architectural and cultural regional characters and the inheritance of architectural climate responsiveness in contemporary times.

© 2022 The Authors. Published by IEREP press. This is an open access article under the CC BY license (<https://creativecommons.org/licenses/by/4.0/>). Peer-review under responsibility of ESSD's International Scientific Committee of Reviewers.

### **Keywords**

*Traditional vernacular house; Xiashanhu house; New rural house; Parametric methods; Climate-responsive design*

---

### **1. Introduction**

In the Chaoshan region in South China, many traditional vernacular houses are widely distributed, and many projects are underway on the reconstruction or new construction of rural houses dominated by residents or the government. There is an urgent need to extract and apply the design strategies of traditional houses for contemporary projects. Then we can preserve the architectural and cultural regional characters and inherit the excellent performances on architectural climate responsiveness. However, the related practices at present are mainly qualitative (imitating appearance and plan form or using materials and components) rather than quantitative ways. Besides, the key design factors and techniques for maintaining the architectural performances are still not fully revealed. Taking Xiashanhu

houses, the most representative traditional vernacular houses in Chaoshan, as the object, this study aimed to investigate the climate-responsive design techniques of traditional houses and to apply the techniques to the new rural houses.

<b>Nomenclature</b>	
CH	Cornice height
EOL	Eave oversailing length
HD	Hall depth
HLW	Horizontal lane width
HTC_R	Heat transfer coefficient of roof
HTC_W	Heat transfer coefficient of wall
HW	Hall width
PPD	The percentage of dissatisfaction
PD	Patio depth
RW	Room width
RDD	Recessed door depth
SAR_W	Solar-radiation-absorption ratio of wall
SC	The sensitivity coefficient
SL	Shading length
SW	Street width
TII_R	Thermal inertia index of roof
TII_W	Thermal inertia index of wall
TPR	Thermal comfort period ratio
VLF_W	Visible light reflectance of wall
VLW	Vertical lane width
WWR	Window-to-wall ratio

### **1.1. Site and climate**

Lingnan traditional houses, mainly including Guangfu, Kejia, and Chaoshan vernacular houses, are located in the hot-humid area in South China. The hot-humid area is classified into the humid subtropical climate regions (Cfa/Cwa) in the Köppen-Geiger climatic map (Beck, H. et al., 2018), as shown in Figure 1. Taking Shantou city, where Xiashanhu houses are mainly distributed, as an example, the local climate was analyzed as follows.

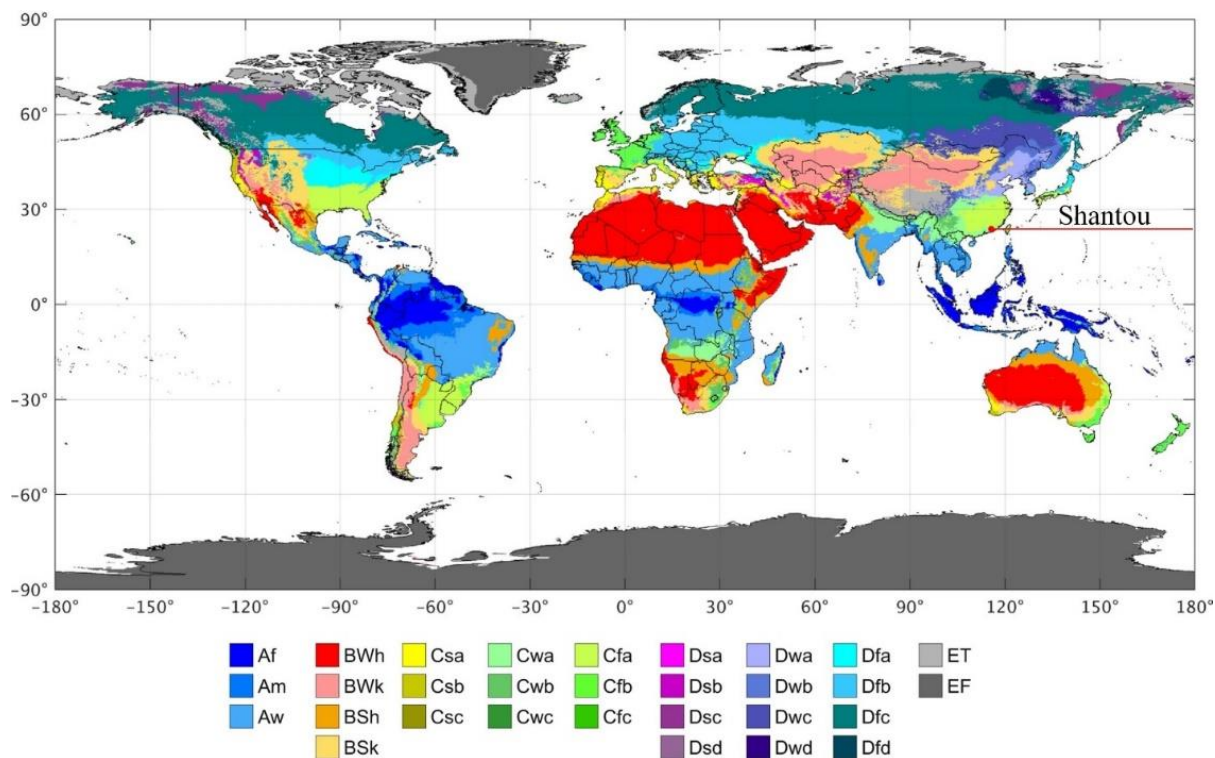

Figure. 1 The present-day map (1980–2016) of Köppen-Geiger climate classification

Shantou is located at 116.4° East longitude and 23.21° North latitude, with an altitude of about 587m above sea level. The climate data of Shantou were obtained from (China Meteorological Data Network, 2020), which covered the climatological period from 1981–2010, as shown in Table 1. The summer (June to August) is hot and humid, with temperatures around 27.5-29.1°C and relative humidities around 78-82%. The winter (December to February) is temperate, with temperatures around 14.7-16.6°C and relative humidities around 70-76%. The sunshine hours are long, and the rainfall is abundant in summer in Shantou.

Table 1 Average climate data in Shantou from 1981 to 2010

Month	Jan	Feb	Mar	Apr	May	Jun	Jul	Aug	Sep	Oct	Nov	Dec
Mean temperature (°C)	14.7	15.8	17.8	21.6	25.2	27.5	29.1	28.9	27.9	25.1	20.8	16.6
Max. temperature (°C)	19.0	20.0	21.9	25.4	28.7	30.8	32.8	32.4	31.6	28.7	24.9	20.9
Min. temperature (°C)	11.7	13.0	14.9	18.9	22.6	25.1	26.4	26.1	25.1	22.0	17.3	13.2
Rainfall amount (mm)	28.0	68.3	103.6	171.9	207.7	273.1	225.2	280.5	162.9	31.4	32.1	33.2
Rainfall days (≥0.1mm)	7.2	10.8	12.7	13.3	15.3	17.1	13.4	13.7	9.9	5.2	4.8	5.2
Mean relative humidity (%)	73	76	75	77	78	82	78	79	75	69	71	70
Sunshine hours (h)	143.2	96.0	101.7	112.8	134.7	170.9	239.7	218.6	200.7	207.6	181.2	171.5

Besides, Givoni's bioclimatic chart in Shantou (B. Givoni. Man, 1969) was plotted using Climate Consultant 6.0 and Photoshop as Figure 2 shows. The comfort zones are centralized in transition seasons and winter, indicating that summer is the significant period for thermal performance improvement. By using different design strategies, thermal comfort performance can be improved to some extent in different seasons. In winter, moderate internal heat gain (such as lights, people, and equipment) can maintain indoor thermal comfort. In summer, both sun shading (preventing solar radiation) and natural ventilation (taking away the heat) can contribute to indoor thermal comfort. Besides, even though active dehumidification and cooling are also effective, there are no discussions about them because the passive ways are focused on in this study. Some strategies are not plotted in the figure on account of lower effects, i.e., high thermal mass and heating.

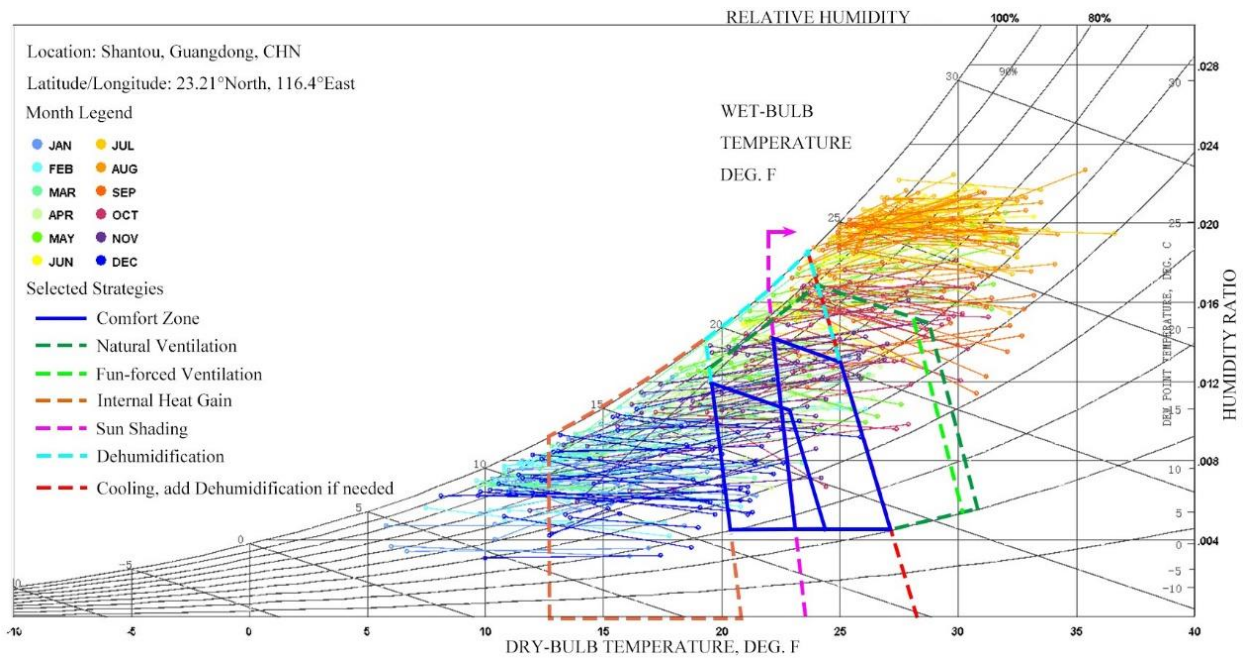

Figure. 2 The bioclimatic chart of Shantou

## 1.2. Climate-responsive design of Lingnan traditional houses

There are many practices of Lingnan traditional houses in responsive to the hot-humid climate, such as small or no windows, plan form with patio, and compact street layout et al. Xiashanhu houses are the most representative Chaoshan houses. Its layout is similar to that of Lingnan traditional houses, i.e., patio, kitchen and storage rooms in the front, hall and bedrooms in the back, and single-storey (Lu and Wei, 1990; Lu, 2008), as shown in Figure 3. Xiashanhu houses were chosen as the research object in this study as:

They were widely promoted due to their economic and technical benefits, especially in modern times, and widely distributed now in many traditional villages with the comb layout (Chen, 2014);

The layout of contemporary rural houses follows that of Xiashanhu houses, i.e., hall and patio in the middle, and bedrooms and other rooms on both sides (Jin, 2014).

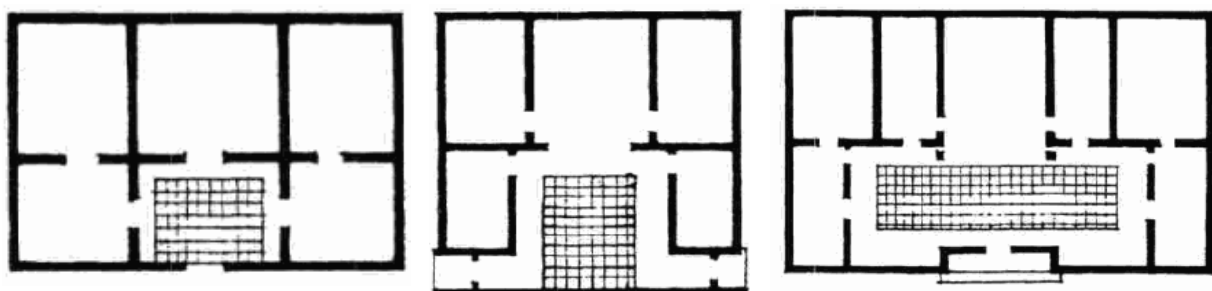

Figure. 3 The typical plans of Xiashanhu houses

Many studies investigated the climate-responsive design of Lingnan traditional houses based on field observations or measurements. For instance, Chen (Chen, 1965) pointed out that the layout with patio was important for the traditional houses in aspects of natural cooling and indoor thermal comfort in summer. Li (Li, 1993) conducted a field study on the Qing Dynasty houses in Foshan. He found that both the street layout and construction techniques contributed to the decrease and stability of the indoor temperature and the good natural ventilation. The studies (Zeng et al., 2009; Pan and Gao, 2010) confirmed the good thermal performances of Lingnan traditional houses by testing indoor temperature, humidity, and wind speed. By using PMV, they also confirmed good human thermal comfort in vernacular houses. Simulation tools were adopted in some studies as well. For instance, Ma (Ma, 2011) used Fluent to study the natural ventilation in Chen Clan Temple. Li (Li, 2013) adopted ENVI-met and EnergyPlus to study the Pearl River Delta villages, focusing on both outdoor and indoor thermal environments. It can be learned from the previous studies that thermal performance is important for understanding the climate-responsive design of Lingnan traditional houses. Meanwhile, the design factors influencing thermal performance include the parameters of the building, opening, shading, construction, and street layout. Furthermore, only a case or small cases are focused on in the majority of previous studies. The key design factors determining the climate responsiveness of traditional houses are still not fully understood, even in the studies with cases in a large sample like (Hui, 2016).

### 1.3. Design guidances on new rural houses

Some guidelines and studies offered design guidances on the new rural houses in Guangdong, China. A document recently issued by the local government (Guangdong Provincial Department of Housing and Urban-Rural Development, 2021) stated that the new rural houses in Chaoshan should fully consider the current situation of residential land and absorb the architectural elements of traditional houses. Jin (Jin et al., 2014) suggested retaining patios in the new rural houses as the semi-open spaces (patio and open hall) were effective for the traditional houses to adapt to the hot-humid climate. She also suggested organizing better natural ventilation by breaking the custom of not opening windows in the north. Chen (Chen, 2014) found that the traditional lane widths of 4m/2m (horizontal/vertical) improved the ventilation at the entrance, patio, and hall of traditional houses. Based on the findings, he suggested the horizontal lane width of 6m in the new villages, together with the well-designed openings' location and size in the new houses. Jin (Jin, 2014) recommended using louvered roof shadings for the new low-rise rural houses with patios and optimizing wall and roof materials to improve the indoor thermal comfort. Yu (Yu, 2011) applied his research result of the optimal patio height-to-width ratio (3:1-5:1) for the traditional houses to the design of a three-storey rural house, which resulted in a good performance.

In summary, it can be known that the current design guidances on new rural houses in Chaoshan are qualitative rather than quantitative:

For the reconstructions, the guidances are mainly focused on materials, appearance, and traditional components (gables, courtyard walls, window panes);

For the new constructions, the guidances are mainly focused on the inheritance of traditional elements, enclosed plan, and functional zoning.

The qualitative guidances have some disadvantages. One is that the dimension rules and design strategies contained in the vernacular houses can not be completely followed, resulting in building performances being not guaranteed. The other is that even for the partial imitations, the operations are always arbitrary.

### 1.4. Applying parametric methods to climate-responsive design of traditional houses

The parametric methods had been widely applied in the performance-oriented modern architectural design. Based on the genetic algorithm, Tuhus-Dubrow (Tuhus-Dubrow and Krarti, 2010) optimized building form and wall-and-roof construction dimensions to reduce building energy consumption. Based on EnergyPlus and jEPlus, Delgarm (Delgarm et al., 2016) optimized building orientation, dimensions of windows and shadings, and construction materials (heat transfer coefficient) to cut down the energy consumption. Using Grasshopper, Ladybug, and Honeybee, Zhang et al. (Zhang et al., 2017) optimized building orientation, depth of rooms and corridors, and WWR to improve energy efficiency, thermal comfort, and daylight.

In recent years, they were also applied in the traditional houses' studies. For instance, Wang et al. (Wang and Liu, 2002) investigated the effects of design factors and determined the key design parameters for the cave thermal environment by introducing the parametric design method. In a historical building in Italy, Roberti et al. (Roberti et al., 2017) assessed the airtightness of doors and windows and ventilation performance, and proposed reconstruction schemes oriented towards cooling/heating loads and thermal comfort by using the parametric method. Based on the Grasshopper and plug-ins, Zhu et al. (Zhu et al., 2020) optimized the energy consumption, daylight factor, and predicted percentage dissatisfied (PPD), considering the plane layout, air conditioner setting temperature, and building shape and façade.

It can be summarized from the above literature review that:

Only a case or cases in a small sample are focused in the majority of previous studies, and the key design factors determining the climate responsiveness of traditional houses are still not fully understood.

The current design guidances on new rural houses are qualitative rather than quantitative.

The parametric methods have unique advantages in generating large sample cases, studying the impact of multiple design parameters on various performances, and guiding the optimal design schemes.

This study aims to study and apply the climate-responsive design of Xiashanhu houses in Chaoshan, China. The specific goals are as follows: (i) to investigate the basic design factors and to generate the parametric models in a large sample; (ii) to screen the key climate-responsive design factors oriented towards thermal performance; (iii) to determine the solution set of key design factors by objective optimization; and (iv) to verify the rationality and validity by applying the climate-responsive design of the traditional houses to a new rural house. This study will provide valuable references for the research and modern applications of the climate-responsive design of traditional vernacular houses.

## 2. Methods

A parametric platform was established for this study using the Rhinoceros & Grasshopper software and the referred plug-ins. The platform consisted of three modules: the parametric modeling module, the building performance calculation module, and the sensitivity test and optimization module.

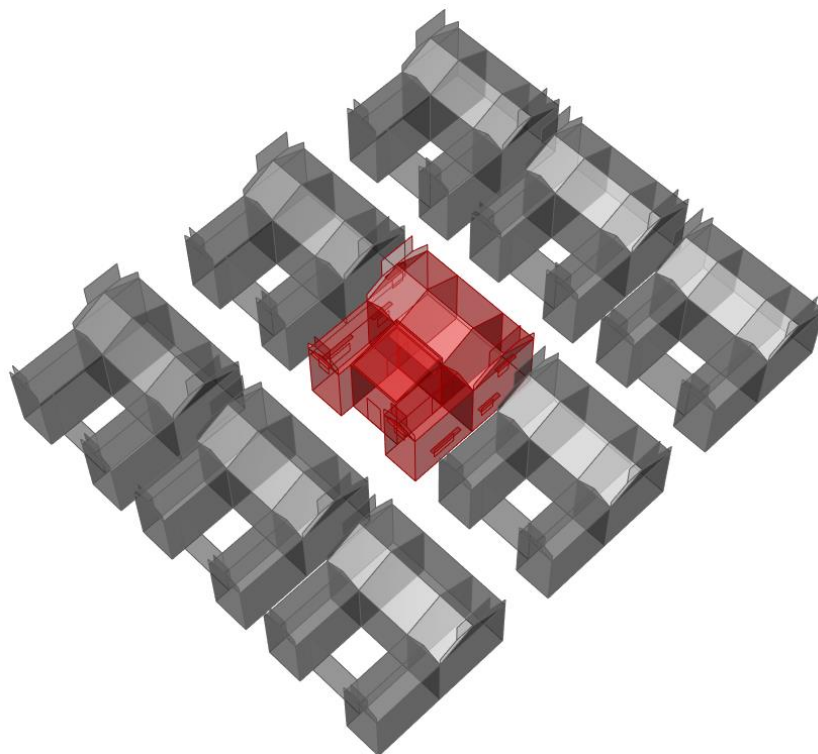

Figure. 4 A Xiashanhu parametric model (target building in red and surrounding buildings in gray)

### 2.1. Parametric modelling

The parametric modeling module generated the Xiashanhu parametric models according to the design parameters of Xiashanhu houses (see Figure 4), with the generation order of single building, opening and shading, constructions, and street layout. The parameter values and the abstract plan are summarized as follows.

The abstract plan for the Xiashanhu parametric models (Fig. 5) was obtained from the typical traditional plans (Fig. 3) that slightly modified in the frontage door according to the common situations of contemporary rural houses.

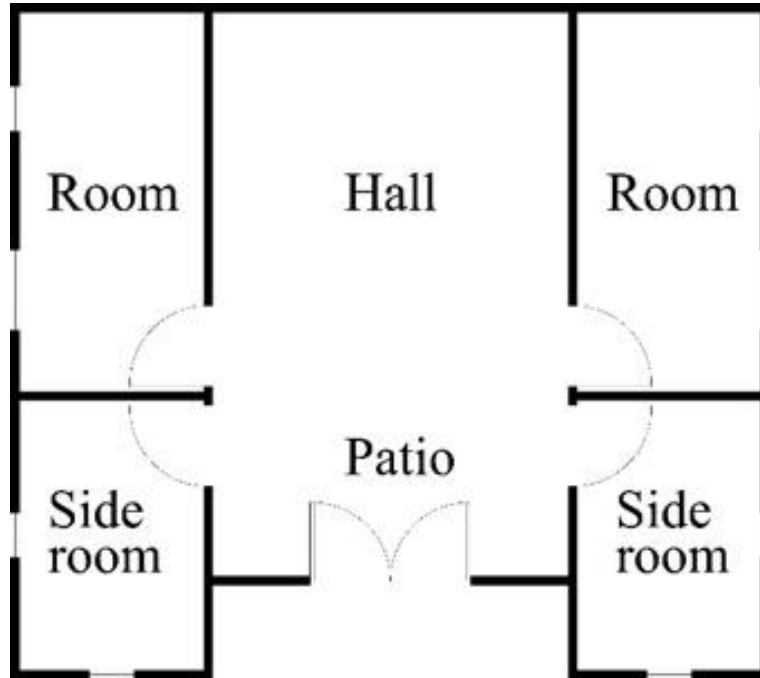

Figure. 5 The abstract plan of Xiashanhu parametric models

The building parameters included the values of width, depth, and height for the spaces of the hall, room, side room, and patio (Figs. 6, 7), and the data for Xiashanhu houses were obtained from the refs. (Lu&Wei, 1990; Lu, 2008), including both the interval and range as shown in Table 2.

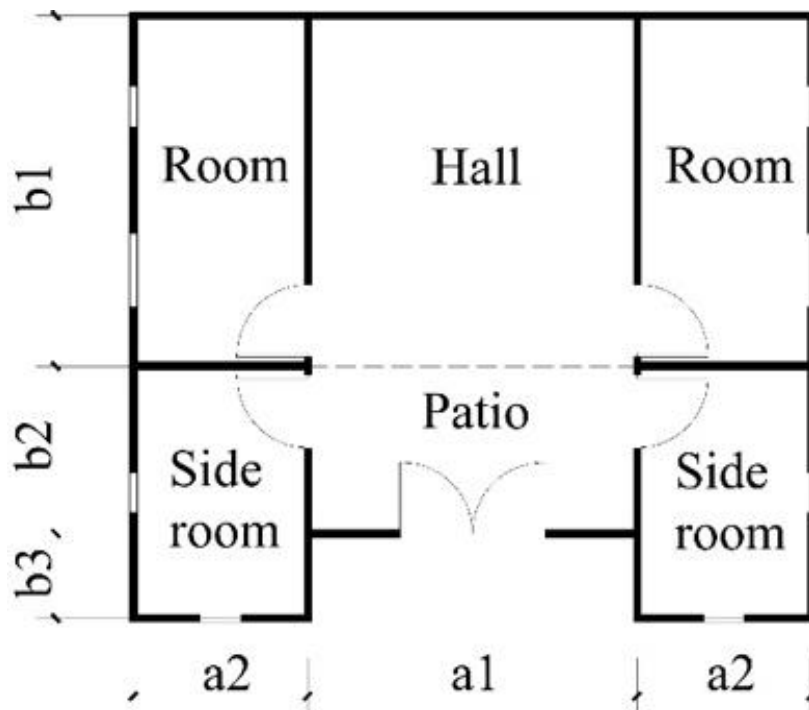

Figure. 6 The width and depth of Xiashanhu houses(a1: HW, a2: RW, b1: HD, b2: PD, b3: RRD)



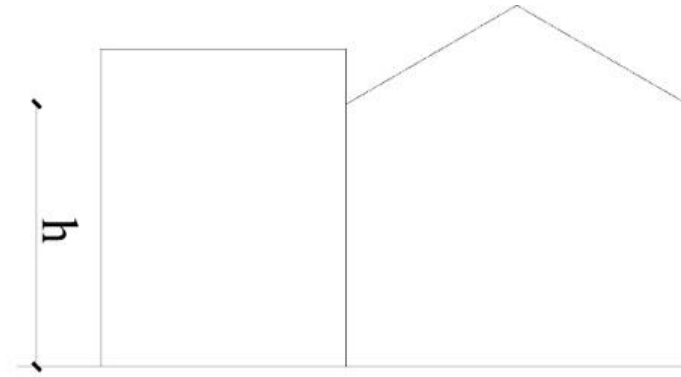

Figure. 7 The height of Xiashanhu houses (h: CH)

Table 2. The building parameters of Xiashanhu houses (mm)

Parameter		Hall	Room	Side room	Patio
Width	Interval	270	270	=RW	=HW
	Range	4050-5670	2700-4320		
Depth	Interval	540	=HD	=PD+RRD	2700
	Range	4340-7040			4050-6750
CH	Interval	180	=CH of hall	=CH of hall	=CH of hall
	Range	2760-5100			
Slope	Value	25°			

The opening parameters were determined according to (Lu&Wei, 1990; Lu, 2008; Chen, 1963; Gao, 2007; Zeng, 2010; Cheng, 2013; Tang, 1996; Tang, 2001) as shown in Figure 8, with the WWR range and interval of 0.02-0.1 and 0.02.

The opening shading parameters were obtained from (Lu, 2005; Zhang, 2015; Qiu, 2017) as shown in Figure 9, with the RRD range and interval of 340-1960mm and 180mm. The gable wall is a representative design of Lingnan traditional houses, and the gable wall shading parameters of Xiashanhu houses are shown in Figure 10, with the range and interval of 310-1390mm and 180mm for the eave oversailing length (Lu&Wei, 1990; Lu, 2008).

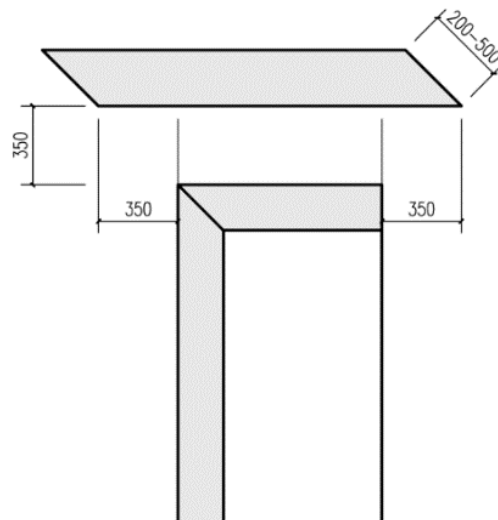

Figure. 8 The opening shading parameters of Xiashanhu houses (unit: mm)



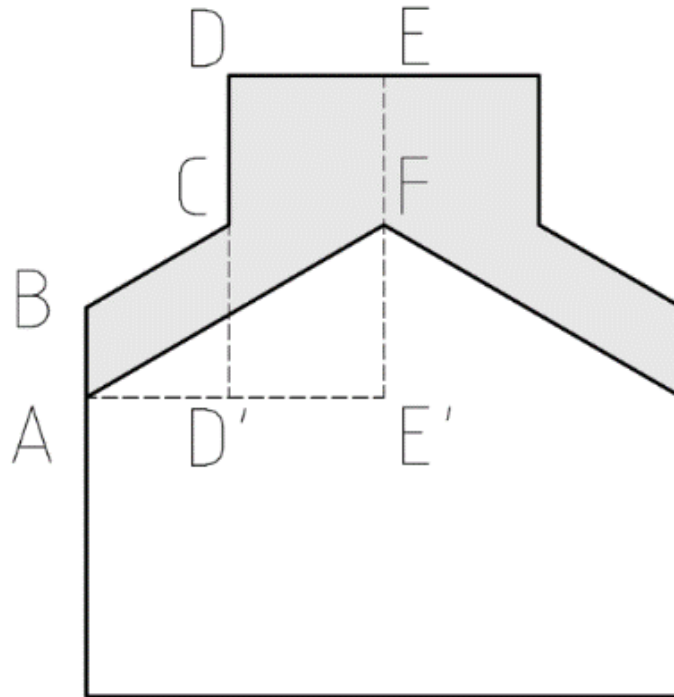

Figure. 9 The gable wall shading parameters of Xiashanhu houses

The constructions of wall, roof, windows, and floor were determined for Xiashanhu houses, referring to (Tang, 2005) for the details. Xiashanhu houses are in a low-density community layout, with the range and interval of 1100-2900mm and 300mm for the vertical lane width, and 0-1800mm and 300mm for the horizontal lane width (Lu&Wei, 1990; Lu, 2008; Chen, 2014; Hui, 2016; Qi, 2013).

## 2.2. Thermal performance evaluation

The building performance calculation module evaluated the thermal performances of all Xiashanhu parametric models by using the Ladybug plug-in to call simulation software of EnergyPlus. As stated in the introduction, thermal performance is important for understanding the climate-responsive design of Lingnan traditional houses. We adopted a thermal comfort index reflecting the integrated thermal impacts of temperature, radiation, wind speed, and humidity on inhabitants to evaluate the thermal performance of Xiashanhu houses. Based on a recent study in the hot-humid area of China combining climate chamber experiments and field surveys (Zhang, 2018), a modified PMV-PPD model was used for the thermal comfort calculation of local people.

The percentage of dissatisfaction (PPD) was calculated by (Fanger, 1970) together with the modified equation by (Zhang, 2018). For the calculation, the metabolic ratio and clothing insulation by (Zhang, 2018) were used as Tables 3-4 show, the indoor air and radiant temperatures and humidity were obtained by the building performance calculation module, and the indoor wind speed was estimated as the opening wind speed converted from the inflow air volume through low openings.

Table 3. The metabolic rate for thermal comfort calculation

Space	Main activities	Metabolic rate (met)
Hall	Sitting	1.0
Room	Sleeping	0.7
Patio	Standing	1.2
Side room	Working (such as cooking)	2.0

Table 4. The clothing insulation for thermal comfort calculation

Space	Summer (Apr 24 to Nov 20)	Non-summer (Nov 21 to Apr 23)
Indoor spaces (Room and side room)	0.30 clo	$I_{cl} = -0.040t_o + 1.517$
Semi-open spaces (Patio and hall)	0.29 clo	$I_{cl} = -0.026t_o + 1.193$

The PPD that no more than 20% was identified as comfortable, and the TPR was calculated by:

$$TPR = \frac{\sum_{i=1}^N (TP_i/t_i)}{N} \times 100\% \quad (1)$$

Where  $TP_i$  is the annual thermal-comfort hours of the  $i$ -th space;  $t_i$  is the annual usage hours of the  $i$ -th space;  $N$  is the number of spaces in a house.

For the indoor thermal environment simulation, the personnel density and per-capita calorific values were determined according to function and people's activities in the space (Table 5), the thermal disturbance values were all set to 0, and the hourly in-room ratios of people were estimated by the modern people' timetable as follows:

Hall: 100% for 9:00-13:00 and 14:00-22:00, and 0 for the rest;

Room: 100% for 23:00-8:00, and 0 for the rest;

Patio: 50% for 9:00-13:00 and 14:00-22:00, and 0 for the rest.

Side room: 100% for 8:00-9:00, 11:00-13:00, and 18:00-20:00, and 0 for the rest.

Table 5. The personnel density and per-capita calorific values

Space	Hall	Room	Patio	Side room
Personnel density (people)	3	2	3	1
Per-capita calorific value /W	108	72	126	207

### 2.3. Sensitivity analysis and objective optimization

The sensitivity test module tested the sensitivities of various design factors and screened out the key climate-responsive design factors based on the thermal performances of all Xiashanhu parametric models. The local sensitivity analysis method was used, with the sensitivity coefficient calculated by equation (2) (Lam and Hui, 1996). The top five design factors in the ranking of sensitivity coefficient were identified as the key design factors and entered the objective optimization with the other factors maintaining constants.

The objective optimization module determined the optimized designs among all Xiashanhu parametric models oriented thermal performance by linking the calculation software and Galapagos plug-in. The parameters set for the objective optimization were referred to (Shen, 2012), as Table 6 shows. We took the first 5% of the designs when the thermal performance indices were optimal as the optimized solutions. The optimized values of key design parameters that occurred most often in the optimized designs were determined as the optimal design to be applied in the new rural house (referring to section 3.2).

Table 6. The parameters for objective optimization

Parameter	Max. Stagnant	Population	Initial Boost	Maintain	Inbreeding
Value	20-50	50	2	5%	75%

$$SC = \left( \frac{\Delta OP}{\Delta IP} \right) \div \left( \frac{\overline{OP}}{\overline{IP}} \right) \quad (2)$$

Where SC is the sensitivity coefficient; IP is the independent variable; OP is the dependent variable.

#### 2.4. Application in a new rural house

A modern Chaoshan rural house in Shantou was selected as the application case. The case is representative in the area, with the plan following Xiashanhu houses and in a low-density village layout. The general plan, actual and interior photos, and plan dimensions are shown in Figures. 11-13, and the design factors are listed in Table 9 for the application case.



Figure. 10 The target village in Shantou, China, captured from Google Earth (the target house in red)

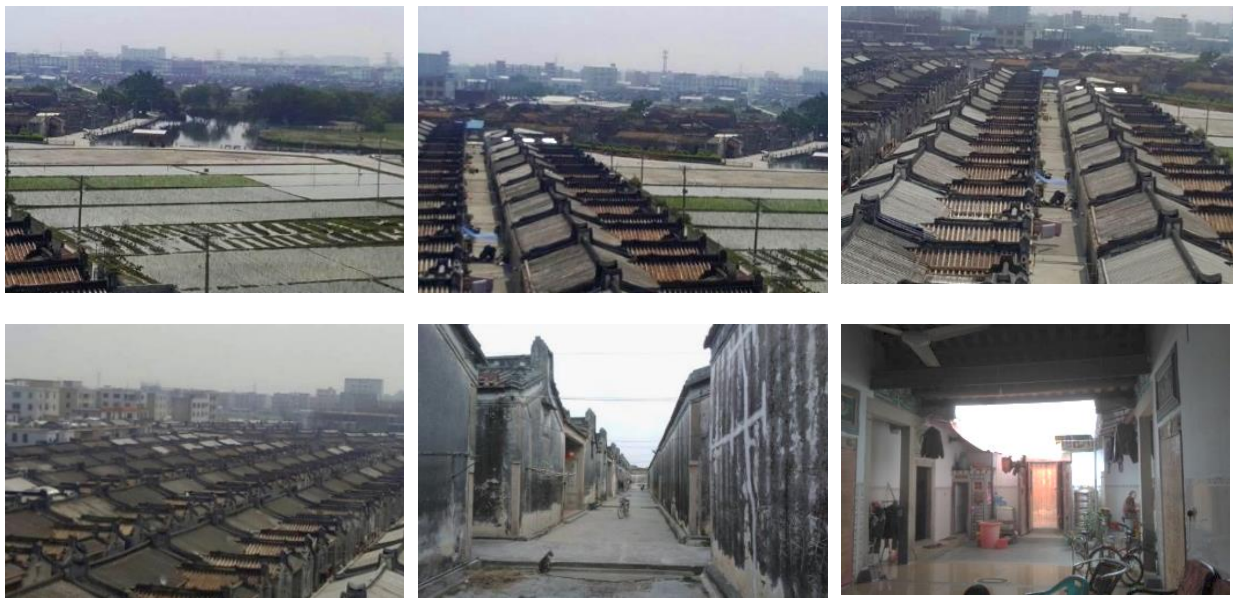

Figure. 11 The actual and interior photos of the application case (Chen, 2014)

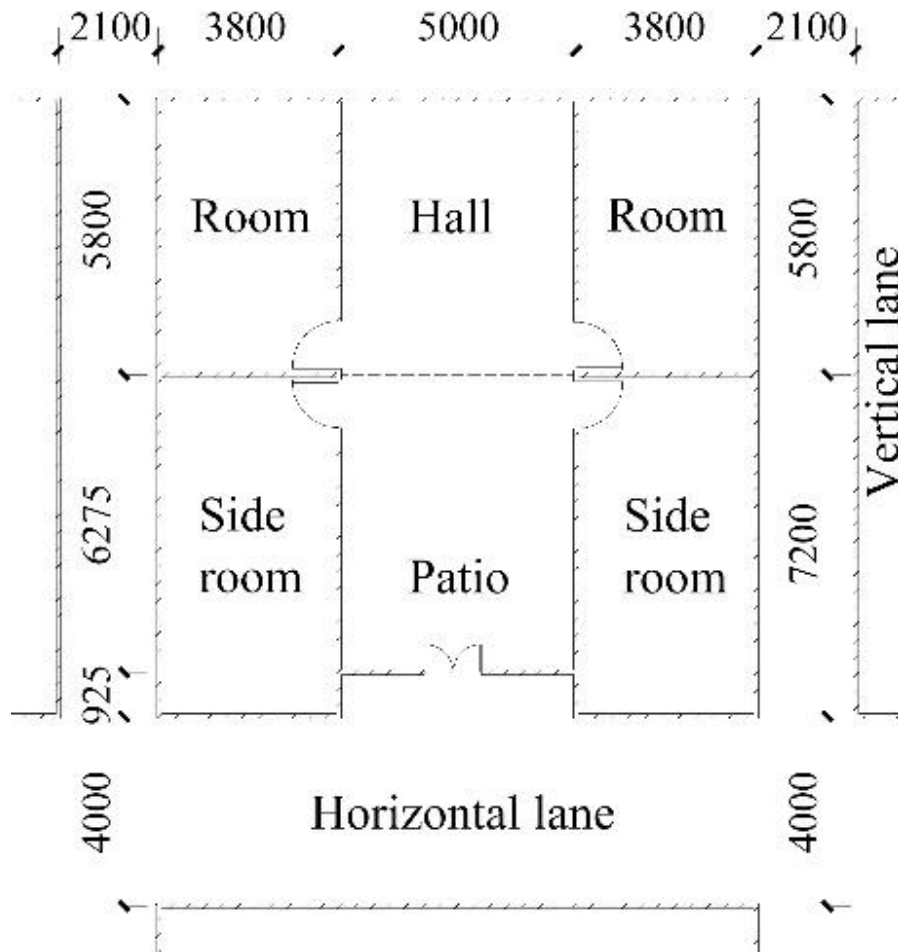

Figure. 12 The plane dimensions of the application case

The reconstruction schemes were generated for the application case using the key design parameter values of the optimal designs. The first set of schemes were achieved by optimizing the key climate-responsive design factors (referring to section 3.1) one by one, and the last scheme was achieved by simultaneously optimizing all the key design factors. The new schemes are different from the original case only in the key design factors, and these various reconstruction schemes were proposed to adapt to the diversified situations in practice. Lastly, the difference ratio was used to describe the performance improvement by optimization by equation (3).

$$P = \frac{A - B}{B} \times 100\% \quad (3)$$

Where  $P$  is the difference ratio;  $A$  is the performance index of the new case;  $B$  is the performance index of the original case.

### 3. Results

#### 3.1. Key climate-responsive design factors

Totally 128 Xiashanhu parametric models were generated by combinations of the various design parameters in section 2.2. Based on the thermal comfort index calculation, the sensitivity coefficients of each design factor to the thermal performance of Xiashanhu houses were obtained in Figure. 14. Since the parameters of TII\_W, SAR\_W, and HTC\_W were all for wall construction, the five factors of CH, HW, orientation, RW, and wall construction that had the bigger sensitivity coefficients were identified as key climate-responsive design factors for Xiashanhu houses.

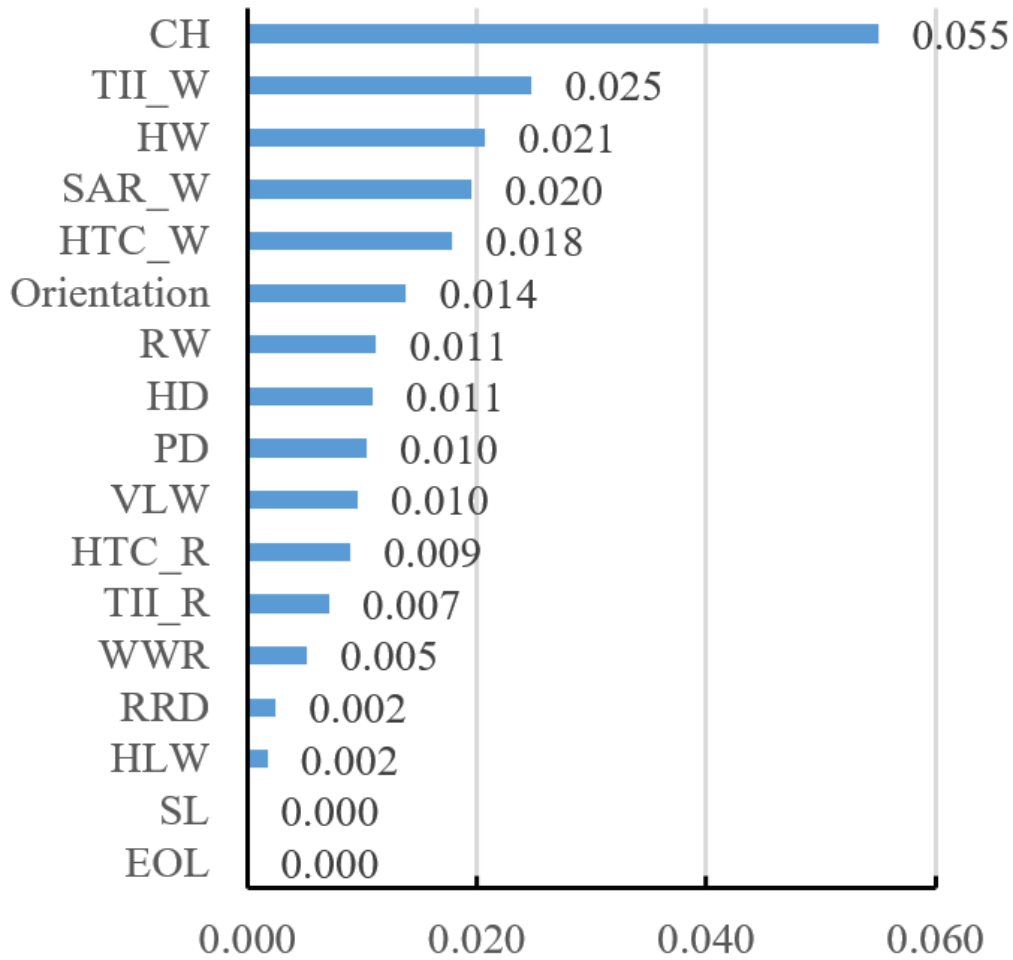

Figure. 13 The sensitivity coefficients of design factors for Xiashanhu houses

### 3.2. Optimized climate-responsive designs

The 76 optimized climate-responsive designs were obtained by objective optimization for Xiashanhu houses. The optimized results are shown in Table 7, with all design parameter values listed on the right column, the optimized values marked in grey, and the optimized values that are most common in practices in the box.

Table 7 The parameters for optimized climate-responsive designs

Key design factor	All and optimized values
HW/m	4.05 4.32 4.59 4.86 5.13 5.4 5.67
RW/m	2.7 2.97 3.24 3.51 3.78 4.05 4.32
CH/m	2.76 2.94 3.12 3.3 3.48 3.66 3.84 4.02 4.2 4.38 4.56 4.74 4.92 5.1
Orientation/°	0 15 30 45 60 75 90 105 120 135 150 165 180 195 210 225 240 255 270 285 300 315 330 345
Wall construction	Rammed earth wall Adobe wall Brick and concrete wall Solid-brick wall Double-brick wall Triple-brick wall

It can be known that the optimized values of HW and RW were the smaller ones, the optimized values of CH were the larger ones, the optimized orientation was from 30°NW to 30°NE (150°-210° in Table 6), and the optimized walls were brick and concrete walls. The optimized values that occurred most often in the optimized climate-responsive designs were determined as the optimal design (Table 8).

Table 8. The parameters for the optimal climate-responsive design

Key design factor	Optimal values	Frequency
HW/m	4.05	47/76
RW/m	2.7	38/76
CH/m	5.1	49/76
Orientation/°	180	21/76
Wall construction	Brick and concrete wall	71/76

### 3.3. Reconstruction schemes of new rural house

The six construction schemes of the new rural house were generated using the optimal climate-responsive design of Xiashanhu houses, which design parameters are shown in Table 8 together with those of the original case. The new schemes are different from the original case only in the key design factors, as shown in grey in Table 9.

Table 9. The design parameters of new rural house for original and new schemes

Design factor	Original case	Scheme 1	Scheme 2	Scheme 3	Scheme 4	Scheme 5	Scheme 6
HW/m	5	4.05	5	5	5	5	4.05
RW/m	3.8	3.8	2.7	3.8	3.8	3.8	2.7
CH/m	3.6	3.6	3.6	5.1	3.6	3.6	5.1
HD/m	5.8	5.8	5.8	5.8	5.8	5.8	5.8
PD/m	6.27	6.27	6.27	6.27	6.27	6.27	6.27
RRD/m	0.93	0.93	0.93	0.93	0.93	0.93	0.93
EOL/m	0.85	0.85	0.85	0.85	0.85	0.85	0.85
WWR/m	0.06	0.06	0.06	0.06	0.06	0.06	0.06
SL/m	0.3	0.3	0.3	0.3	0.3	0.3	0.3
VLW/m	2.1	2.1	2.1	2.1	2.1	2.1	2.1
HLW/m	4	4	4	4	4	4	4
Orientation/°	30	30	30	30	180	30	180
Wall construction	Solid-brick wall	Solid-brick wall	Solid-brick wall	Solid-brick wall	Solid-brick wall	Brick&concrete wall	Brick&concrete wall
Roof construction	Tripling tiles	Tripling tiles	Tripling tiles	Tripling tiles	Tripling tiles	Tripling tiles	Tripling tiles



### 3.4. Performance of optimized designs and reconstruction schemes

The thermal performances of the original rural house and the reconstruction schemes are shown in Table 10, confirming the validity of the reconstruction designs with the different ratios of 5.18-9.98%. Furthermore, the design factors ranked in the aspect of performance improvement by CH, orientation, HW, wall construction, and RW, and the improvement of multi-factor reconstruction scheme was greater than that of single-factor.

Table 10. The TPRs of the existing rural house and new schemes

	Original case	Scheme 1	Scheme 2	Scheme 3	Scheme 4	Scheme 5	Scheme 6
TPR	54.1	57.1	56.9	58.2	57.4	57.1	59.5
The different ratio/%	-	5.55	5.18	7.58	6.10	5.55	9.98

The rationality and validity of the optimized designs of Xiashanhu houses and the reconstruction schemes of the new rural house were further analyzed by following the building physics and climate-responsive design principles. According to section 1.1, Xiashanhu houses generally have good thermal performance in the transition seasons and winter, indicating that the summer is the time of concern for the thermal performance improvement of the houses. Besides, during the summer daytime, the thermal performance of Xiashanhu houses is mainly influenced by indoor radiation, opaque envelope radiation, and natural ventilation. The indoor radiation enters the room through windows and patio openings, the opaque envelope radiation is controlled by the area of the opaque envelope and building orientation, and the natural ventilation is mainly affected by the orientation and opening area.

The HW affects the patio opening area and the corresponding opaque envelope area. Smaller HW values were shown in the optimized designs of Xiashanhu houses and in the reconstruction scheme 1 of the rural house. A better thermal performance was achieved by a smaller HW due to the less indoor solar radiation from the smaller patio opening area and the opaque envelope radiation from the smaller opaque envelope area, which had a similar principle with the sun shading strategy in Figure. 2. Similarly, a better thermal performance was achieved by a smaller RW due to the smaller areas of the relevant opening and opaque envelope.

The CH affects the opening area as well as the shading from surrounding buildings. The larger CH value was chosen in the reconstruction scheme 3 of the rural house. A larger CH produces greater indoor radiation through a larger opening while providing more shadings from surrounding buildings. The two aspects have opposite effects on thermal performance. The optimized designs of Xiashanhu houses are focused on the larger CH values, indicating that the positive effect of strengthening shadings is stronger than the negative effect of increasing opening area, which supports the rationality of the reconstruction scheme 3 as well.

The orientation affects the received solar radiation and natural ventilation. Compared with the orientation distribution of total solar radiation (Fig. 15), it can be found that the orientations in the optimized designs and the reconstruction schemes fall well within the range of lower solar radiation, resulting in less solar radiation and better thermal performance. This demonstrated the significance of lower solar radiation in summer as Figure. 14.

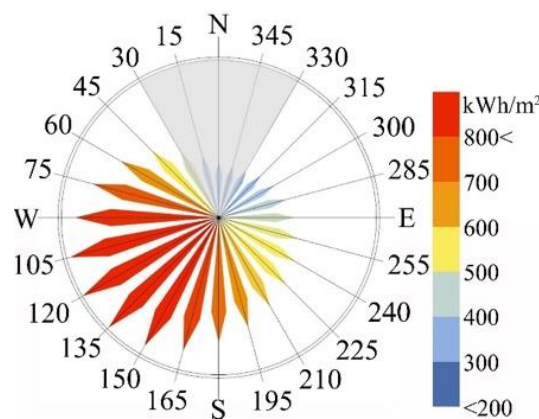

Figure. 14 The orientation distribution of total solar radiation



Two thermal properties of wall construction, i.e., heat transfer coefficient and thermal inertia index, affect the thermal performance of buildings. The heat dissipation can be improved by a larger heat transfer coefficient and a smaller thermal inertia index, i.e., a smaller ratio of thermal inertia index to heat transfer coefficient ( $D/K$ ), and the opposite is true for heat insulation. The thermal properties of the six wall constructions in Xiashanhu houses are listed in Table 11. The  $D/K$  values of the optimized designs are in the middle, indicating that the good thermal performance of Xiashanhu houses can be achieved by balancing heat insulation and dissipation. This is consistent with the hot-humid climate characteristic of intense solar radiation in the daytime and low air temperature at night in summer, as well as the building heat transfer feature of heat insulation (heat transfer from outside to inside) in the daytime and heat dissipation (heat transfer from inside to outside) at night. This is also consistent with the low effects of high thermal mass strategy in Figure. 2. The optimized  $D/K$  values of the wall were therefore determined to be in the range of 2-3 for Xiashanhu houses, and that of the reconstruction scheme 5 fell well in this range.

Table 11. The thermal properties of wall constructions in Xiashanhu houses

Wall constructions	Heat transfer coefficient $K(W/(m^2 \cdot K))$	Thermal inertia index $D$	$D/K$
Double-brick wall	1.65	2.98	1.8
Solid-brick wall	1.77	3.62	2.0
Rammed earth wall	1.82	4.44	2.4
Brick and concrete wall	1.74	4.78	2.7
Adobe wall	1.27	5.17	4.1
Triple-brick wall	0.96	4.67	4.9

It can be seen from the above analysis that the reconstruction schemes 1-5 can improve the thermal performance of the rural house through five key design factors respectively. Although the action paths are quite similar, the effects of the five design factors are superimposed rather than offset each other, resulting in a greater improvement by multi-factor reconstruction scheme than that of single-factor.

#### 4. Discussion

Taking the widely distributed Xiashanhu houses as the object, this study discovered the climate-responsive design of Chaoshan vernacular houses oriented towards thermal performance, and verified the rationality and validity by applying the design to a new rural house. In such a process of 'using the past for the present,' the actual situation and needs of the modern buildings should be fully considered and met to ensure usability and effectiveness.

Jia (Jia, 2012) pointed out that the height of Chaoshan vernacular houses was mostly 5m. In this study, larger CH values are shown in the optimized designs of Xiashanhu houses (4.74m, 4.92m, and 5.1m), which are consistent with the majority of traditional ones. Nevertheless, the results could not be suitable for all new rural houses as the traditional houses are mostly single-storey while the new houses can be multi-storey. The optimized climate-responsive designs for multi-storey houses should be further studied by taking into account the essential difference between multi- and single-storey houses as well as the current limitations on building height (Organized by the Ministry of Housing and Urban-Rural Development, PRC, 2014) and construction cost.

The optimized values of HW (i.e., the patio width) for Xiashanhu houses are 4.05m, 4.32m, and 4.59m in this study, corresponding to the patio height-to-width of 1:1. However, Yu (Yu, 2011) suggested the patio height-to-width of 3:1-5:1 as beneficial for modern buildings' solar radiation protection and ventilation. The main difference is that the former is for the single-storey houses while the latter is for the multi-storey ones. Besides, Dali et al. (Dali et al., 2011) found that in semi-open areas of traditional buildings on the southwest coast of India, MRT was lower than the bedroom (about 1°C). It shows that the semi-open space has better performance than other areas.

HW and RW are closely related to the occupant's space usages. The current standard (Organized by the Ministry of Housing and Urban-Rural Development, PRC, 2014) requires the double bedroom not less than 9m<sup>2</sup>, the living room not less than 10m<sup>2</sup>, and the straight length of the living room wall greater than 3m. Accordingly, the optimized smaller values of HW and RW (HW: 4.05m, 4.32m, 4.59m; RW: 2.7m, 2.97m, 3.24m) in this study meet the usage requirements. The optimized orientation is from 30° north by west to 30° north by east for Xiashanhu houses, and in an actual modern project, the orientation should be flexibly selected and adjusted considering both the topography and planning scheme.

The wall construction is one of the key climate-responsive design factors of Xiashanhu houses, with the rammed earth wall and brick and concrete wall as the optimal. For the modern rural houses, the latter construction is superior to the former from aspects of cost, environmental protection, and thermal performance. Jin (Jin, 2014) suggested optimizing the wall and roof constructions simultaneously for better building thermal performance. In this study, the roof construction is not screened as the key factor to participate in the optimization due to the very few and low-performance roof constructions used in the traditional houses. More high-performance roof and wall constructions emerging in modern rural houses should be covered in future studies.

Chen (Chen, 2014) pointed out that the street width affected both the indoor and outdoor ventilations of Chaoshan vernacular houses, with the greater impact of HLW on the entrance wind speed than that of VLW. This is quite different from the present study, showing that the factors of HLW and VLW have only a few effects and the effect of VLW is slightly greater than that of HLW. This is because the ventilation and wind speed are focused on in the previous study, while the thermal performance that includes temperature, humidity, radiation, and wind speed is the focus of this study. The effect of solar radiation on the thermal performance of traditional houses is stronger than that of natural ventilation, as Section 3.4 shows.

The present study shows that WWR only has few impacts on thermal performance, and the small windows widely existed in traditional houses is the main reason. Chen (Chen, 2014) confirmed that both the location and size of windows affected the indoor ventilation. Furthermore, Jin (Jin, 2014) found that in the low-rise rural houses with patios, the usage of roof louvered shadings was superior to the traditional façade shadings in thermal performance. The location of openings and the new shadings should be considered together with the WWR design in subsequent studies.

To point out, at this time, it is confirmed that the present study can be applied to the rural houses in Chaoshan region of China, with a similar plan following Xiashanhu houses and in a low-density village layout. And based on the detailed identifications of climate-responsive performance in Section 3.4, the application range can be further extended to the ones in the whole hot-humid climate area of China. On the other side, as a general method of learning the wisdom of traditional houses designs and applying to modern buildings by using the parametric method, the present study can be applied much more widely to various climates and regions.

## 5. Conclusions

This study took Xiashanhu houses as the object and investigated their climate-responsive design factors in five aspects of building, opening, shading, construction, and street layout. Totally 128 Xiashanhu parametric models were generated by combinations of various design parameters. Five key climate-responsive design factors were identified based on a-year-round thermal performance evaluation, and 76 optimized climate-responsive designs were obtained by optimization. The optimized designs of Xiashanhu houses were applied to the re-construction of a new rural house to verify rationality and validity. The main conclusions are as follows.

To improve the thermal performance of Xiashanhu houses, the summer daytime is the time of concern. The incident solar radiation, opaque envelope radiation, and ventilation are the main paths. The hall width, room width, cornice height, orientation, and wall construction are the key climate-responsive design factors.

The optimized climate-responsive designs oriented towards the thermal performance of Xiashanhu houses are: the smaller hall width (4.05m, 4.32m, 4.59m), the smaller room width (2.7m, 2.97m, 3.24m), the larger cornice

height (4.92m, 5.1m), the orientation ranged from 30° north by west to 30° north by east, and the brick and concrete wall.

The rationality and validity of the optimized climate-responsive designs of Xiashanhu houses were verified by applying the optimized designs to the re-construction of a new rural house and achieving significantly improved thermal performance by 5.18-9.98% compared to the original case.

The actual situation and needs of the modern buildings need to be fully considered and met to ensure the usability and effectiveness of 'using the past for the present', and this study makes a detailed discussion on the case of Chaoshan houses.

This study is believed to provide valuable references for the research and modern applications of climate-responsive designs of traditional vernacular houses.

### Acknowledgement

This work was supported by the Provincial Science and Technology Plan Projects in Guangdong Province “Guangdong Housing and Urban-Rural Construction Science and Technology Collaborative Innovation Center (2018B020207015)” and National Natural Science Foundation of China “Integrated Study and Application of Climate Adaptability of Guangdong Vernacular Buildings (52178074)”.

### References

- Beck, H. E., Zimmermann, N. E., McVicar, T. R., Vergopolan, N., Berg, A., & Wood, E. F. (2018). Present and future Köppen-Geiger climate classification maps at 1-km resolution. *Scientific data*, 5(1), 1-12.
- China Meteorological Data Network - WeatherBk Data. (2020). *China Meteorological Administration*.
- Givoni, B. (1969). *Man, climate and architecture*. Elsevier Publishing Company Limited, Amsterdam/London/New York.
- Lu, Y., & Wei, Y. (1990). *Guangdong Vernacular Houses*. China Architecture & Building Press.
- Lu, Q. (2008). *Guangdong Vernacular Houses*. China Architecture & Building Press.
- Chen, J. (2014). *Natural Ventilation System Research of Traditional Villages and Vernacular Houses in Chaoshan Area* [Doctoral dissertation, South China University of Technology].
- Jin, L. (2014). *Climate-Adaptation Research on Chaoshan rural houses* [Doctoral dissertation, South China University of Technology].
- Chen, B. (1965). Patio and the Residential Buildings of Southern Cities: A Discussion from the Perspective of Climate Adaptability. *Journal of South China University of Technology: natural science edition* (04): 1-18.
- Li, M. (1993). Thermal-Environment Study of Qing Dynasty Residential Buildings in Donghuali, Foshan. Academic Committee of Physics, Architectural Society of China. *Selected papers of the 6th academic conference on building physics* (pp. 428-432). Beijing: Science and Technology of China Press.
- Zeng, Z., Lu, Q., & Guo, P. (2009). Field-measurement Analysis of Thermal Environment in Foshan Donghuali houses. *Journal of Guangdong University of Technology*, 26 (4): 70-74.
- Pan, J., & Gao, Y. (2010). The Interior Heat-environment-measurement Analysis of Guangfu Vernacular Houses in Autumn. *Shanxi Architecture*, 36(16):225-226.
- Ma, J. (2011). *Natural Ventilation Effect Study of Cold Alley* [Doctoral dissertation, Guangzhou University].
- Li, K. (2013). *Thermal-environment Study of Typical Village in the Pearl-river-delta Region* [Doctoral dissertation, South China University of Technology].
- Hui, X. (2016). *Climate-adaptation Study of Cold Lane and Courtyard-Space System in Guangfu Traditional Villages* [Doctoral dissertation, South China University of Technology].
- Atlas of Rural House Design Schemes in Guangdong Province (Volume 2)*. (2021). Guangdong Provincial Department of Housing and Urban-Rural Development.
- Jin, L., Zhao, L., Zhang, Y., Wang, H., & Meng, Q. (2014). Field Study and Modern Enlightenment on Thermal Environment of Vernacular Houses in Chaoshan Area. *Building Science*, 30(6):27-32.
- Yu, Z. (2011). *Patio Ventilation Design and Application of Guangzhou Modern Residential* [Doctoral dissertation, Guangzhou University].
- Tuhus-Dubrow, D., & Krarti, M. (2010). Genetic-algorithm based approach to optimize building envelope design for residential buildings. *Building and environment*, 45(7), 1574-1581.
- Delgarm, N., Sajadi, B., Kowsary, F., & Delgarm, S. (2016). Multi-objective optimization of the building energy performance: A simulation-based approach by means of particle swarm optimization (PSO). *Applied energy*, 170, 293-303.
- Zhang, A., Bokel, R., van den Dobbelsteen, A., Sun, Y., Huang, Q., & Zhang, Q. (2017). Optimization of thermal and daylight performance of school buildings based on a multi-objective genetic algorithm in the cold climate of China. *Energy and Buildings*, 139, 371-384.
- Wang, F., & Liu, Y. (2002). Thermal environment of the courtyard style cave dwelling in winter. *Energy and buildings*, 34(10), 985-1001.

- Roberti, F., Oberegger, U. F., Lucchi, E., & Troi, A. (2017). Energy retrofit and conservation of a historic building using multi-objective optimization and an analytic hierarchy process. *Energy and Buildings*, 138, 1-10.
- Zhu, L., Wang, B., & Sun, Y. (2020). Multi-objective optimization for energy consumption, daylighting and thermal comfort performance of rural tourism buildings in north China. *Building and Environment*, 176, 106841.
- Chen, B. (1963). Planar Composition, Floor Number, and Group Layout of Residential Buildings in Southern Cities: A Discussion from the Perspective of Climate Adaptability. *Architectural Journal* (8):6-11.
- Gao, Y. (2007). *Microclimate-environment Research of Traditional Villages in Lingnan Region* [Doctoral dissertation, South China University of Technology].
- Zeng, Z. (2010). *Ventilation Methods in Guangfu Traditional Houses and Applications in Modern Buildings* [Doctoral dissertation, South China University of Technology].
- Cheng, J. (2013). *Zirenshegmo: Selected Maps of Historical Buildings in Lingnan*. South China University of Technology Press.
- Tang, G. (1996). Living Environment of the Unit of Guangzhou Modern Houses. *Huazhong Architecture* (4):108-112.
- Tang, G. (2001). *Selected Maps of Historical Buildings in Lingnan*. South China University of Technology Press.
- Lu, Y. (2005). *Lingnan Humanity, Character, and Architecture*. China Architecture & Building Press.
- Zhang, Z. (2015). *The Traditional House Study on The Village in Zengcheng, Guangzhou* [Doctoral dissertation, South China University of Technology].
- Qiu, G. (2017). *Climate-adaptability Study of Traditional Houses in Leizhou Peninsula* [Doctoral dissertation, South China University of Technology].
- Qi, W. (2013). *Study of Traditional Residential Architectural Forms in the Lower West River Basin* [Doctoral dissertation, South China University of Technology].
- Tang, G. (2005). *Hot-humid Climate and Traditional Houses in Lingnan Region*. China Architecture & Building Press.
- Zhang, Z. (2018). *Thermal Adaptability Study of The Urban-and-rural People in Hot Summer and Cold Winter Region* [Doctoral dissertation, South China University of Technology].
- Fanger, P. O. (1970). *Thermal comfort*. Copenhagen: Danish Technical Press, 110-142.
- Lam, J. C., & Hui, S. C. (1996). Sensitivity analysis of energy performance of office buildings. *Building and environment*, 31(1), 27-39.
- Shen, J. (2012). *Analysis-method Research of Green Building Technology Based on The Grasshopper* [Doctoral dissertation, South China University of Technology].
- Jia, J. (2012). *Natural Ventilation Study of Rural Residentials in Chaoshan Area* [Doctoral dissertation, South China University of Technology].
- Dili, A. S., Naseer, M. A., & Varghese, T. Z. (2011). Passive control methods for a comfortable indoor environment: Comparative investigation of traditional and modern architecture of Kerala in summer. *Energy and Buildings*, 43(2-3), 653-664.
- Organization of the Ministry of Housing and Urban-Rural Development of the People's Republic of China. (2014). *Residential Design Standards*. China Architecture & Building Press.