



## Tensile and fatigue behaviour of as-forged AZ31B extrusion

A. Gryguc, S.K. Shaha, H. Jahed

University of Waterloo (Department of Mechanical & Mechatronics Engineering, 200 University Ave W, Waterloo, ON N2L 3G1, CANADA)

[agryguc@uwaterloo.ca](mailto:agryguc@uwaterloo.ca), [skumarshaha@uwaterloo.ca](mailto:skumarshaha@uwaterloo.ca), [hjahed@uwaterloo.ca](mailto:hjahed@uwaterloo.ca)

<https://uwaterloo.ca/fatigue-stress-analysis-lab/>

M. Wells

University of Waterloo (Department of Mechanical & Mechatronics Engineering, 200 University Ave W, Waterloo, ON N2L 3G1, CANADA)

[mawells@uwaterloo.ca](mailto:mawells@uwaterloo.ca)

<https://uwaterloo.ca/mechanical-mechatronics-engineering/people-profiles/mary-wells>

B. Williams, J. McKinley

CanmetMATERIALS (Natural Resources Canada, 183 Longwood Road South, Hamilton, ON L8P 0A1, Canada)

[Bruce.Williams@nrcan-rncan.gc.ca](mailto:Bruce.Williams@nrcan-rncan.gc.ca), [Jonathan.McKinley@NRCan-RNCan.gc.ca](mailto:Jonathan.McKinley@NRCan-RNCan.gc.ca)

<http://www.nrcan.gc.ca/mining-materials/materials-technology/8234>

**ABSTRACT.** Tensile and stress controlled fatigue tests were performed to investigate the influence of forging at a temperature of 400°C at different rates, on the performance of extruded AZ31B magnesium alloy. The obtained microstructural analysis showed that the extruded AZ31B magnesium alloy possesses a bimodal grain structure with strong basal texture. In contrast, the forged samples showed refined grains and a weaker texture. During tensile testing, a maximum yield and ultimate tensile strength of about 163 MPa and 268 MPa were obtained for the forged samples showing an increase of 102% and 7%, respectively from the as-extruded material. At the same time, a significant improvement of fatigue life was also observed for the sample forged at the rate of 100 mm/min. The fractographic analysis of the fracture surfaces showed that ductile type fractures occurred in both as-extruded and forged samples. However, more dimples and plastic deformation were identified in the fracture surfaces of the forged specimens. It is believed that forging improved the fatigue life by a combination of grain refinement and texture modification resulting in improved yield and ductility.

**KEYWORDS.** AZ31B; Forging; Fatigue Characterization; Fracture; Texture.



**Citation:** Gryguc, A., Shaha, S.K., Jahed, H., Wells, M., Williams, B., McKinley, J., Tensile and fatigue behaviour of as-forged AZ31B extrusion, *Frattura ed Integrità Strutturale*, 38 (2016) 251-258.

**Received:** 13.05.2016

**Accepted:** 23.06.2016

**Published:** 01.10.2016

**Copyright:** © 2016 This is an open access article under the terms of the CC-BY 4.0, which permits unrestricted use, distribution, and reproduction in any medium, provided the original author and source are credited.



## INTRODUCTION

There has been a significant amount of technology development in the past quarter century which has focused on developing lightweight vehicles to address the need for both better fuel economy and decreased emissions in the transportation industry [1]. As the lightest structural metallic material, magnesium and its alloys have shown to be promising candidates for use in vehicle components which are susceptible to fatigue fracture, such as suspension control arms [2]. However, the strong crystallographic texture that can form during processing and anisotropic mechanical properties leads to low ductility at room temperature which limits the uses of wrought magnesium alloys. Numerous studies [3, 4] have been performed with the aim of weakening the crystallographic texture which reduces the anisotropy in mechanical properties. The most commonly reported mechanism for texture weakening of magnesium alloy is introducing rare earth materials. The addition of Y, Nb, Gd, Ce, Ng etc. in magnesium alloys randomizes the texture during hot deformation processes like extrusion, forging and rolling, which causes a reduction of crystallographic texture intensity and activates the basal slip system [4]. However, the cost associated with rare earth elements significantly limits their application. Recently, Sarker et al. [3] proposes multidirectional compression as a method for randomizing the texture and improving the tension-compression asymmetry in magnesium. Though the use of rare earth alloying elements have been shown to weaken texture, it has not been established whether modified texture improves fatigue performance of Mg alloys. A goal of the current work is to better understand the mechanisms affecting fatigue performance of non-rare earth Mg alloys, including both the grain structure and texture.

Although studies utilizing stress controlled fatigue methods provide important information into the design of engineering components [5], most of the published researches were focused on the tension-compression properties and fatigue behavior of cast, extruded, rolled or forged wrought magnesium alloys. For instance, Somekawa et al. [6] studied the fully reversed stress controlled cyclic and compression testing and observed twinning behavior in extruded magnesium alloy. Yin et al. [7] found that under strain controlled cyclic testing the stable crack propagation zone is characterized by a lamellar structure resulting from twinning, whereas the fracture zone has a dimpled morphology resulting from slip. Other studies [8] [9] [10] also investigated the effect of sample direction on fatigue crack growth and propagation in magnesium alloys. More detailed studies [11-18] regarding multiaxial cyclic response, failure mechanism and fatigue life modeling also indicate analogous effects of mechanical processing on the texture evolution, monotonic and cyclic responses. The study of the stress controlled fatigue resistance of extruded then forged magnesium alloy is very limited in the literature, especially in those alloys suitable for automotive structural applications. Specifically, it is not clear how changes in the microstructure and texture of extruded, then forged AZ31B magnesium alloy affect the fatigue performance.

Therefore, the aim of this study was to discuss the sensitivity of forging on both tensile and fatigue properties of AZ31B extruded magnesium alloy. Another objective is to discuss the influence of forging on the microstructure and texture evolution.

## MATERIAL AND EXPERIMENTS

The material used in this investigation was commercially available Mg-Al-Zn magnesium alloy AZ31B. The chemical composition of this alloy in mass percentage is shown below in Tab. 1. The material was received in the form of an extruded billet of diameter 88.9mm in the as-fabricated condition.

Al	Zn	Mn	Al
2.5-3.5	2.5-3.5	2.5-3.5	2.5-3.5

Table 1: Table of AZ31B alloy chemistry in wt. %

Forging trials were conducted at CanmetMATERIALS using AZ31B extruded feedstock of the aforementioned diameter which was cut into 88.9 mm lengths. All tests were carried out on a 500 Ton hydraulic press with an upper and lower platen (die) which were both flat. The billet and tooling were heated separately to a temperature of 400°C. The orientation of the billet to the press was such that the extrusion direction was along the direction of the press stroke (i.e. direction of forging was coincident to extrusion direction of the billet). Forging was carried out at two different rates (10 and 100 mm/min with engineering strain rates of about 0.002 and 0.02 s<sup>-1</sup> subsequently referred to as sample S1 and S2, respectively). The as-extruded material was forged to a height of 13 mm corresponding to 85% compressive engineering

strain and then air cooled. Graphite lubricant was used during the process on all test samples. Although the die temperature remained almost constant throughout the test, heat loss to the surrounding air during forging was expected, particularly for the slower forging rate condition. Fig. 1a and Fig. 1b shows the orientation for which the metallographic, tensile and fatigue tested specimens were extracted from both the extruded and forged billets. For tensile and fatigue tests, different geometry of flat bar and round bar samples were used as shown in Fig. 1c and Fig. 1d. All specimens were taken with their axis coincident with the radial direction of the as-extruded and forged billets.

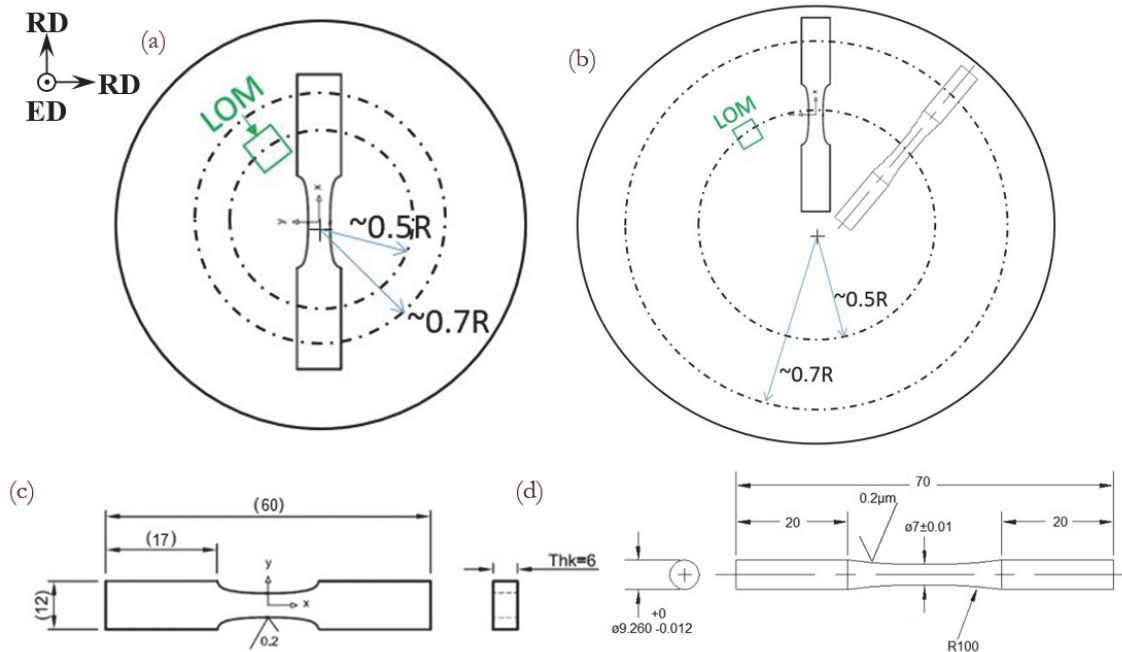

Figure 1: Schematic diagram for sample preparation and extraction. (a) As-extruded billet (b) Forged billet (c) tensile specimen (d) fatigue specimen. All dimensions in mm, Light Optical Microscopy (LOM) specimens taken from a position of 0.5R.

The metallographic samples were prepared following standard metallographic techniques [19]. The microstructure was observed using a light optical microscope and a scanning electron microscope (SEM), coupled with energy-dispersive X-ray spectroscopy (EDS). The texture measurements of the alloy before and after forging tests were performed using a Bruker D8 discover equipped with advanced 2D-detector of X-ray diffractometer on polished samples.

Tensile test samples with a gauge length of 26 mm were extracted from the as-extruded billet and pancake shape forged samples as shown in Fig. 1 a,b. The quasi-static tensile tests were performed using an 8874 Bi-Axial Instron Servo-Hydraulic test machine operating in displacement control mode. The displacement rate of the crosshead was  $10^{-3}$  m/min for all tests, which corresponds to an approximate strain rate of  $1.4E-3$  sec<sup>-1</sup>. Strain measurement was accomplished using a GOM Aramis 3D 5MP DIC system. The fatigue tests were performed in an ambient environment using an Instron R.R. Moore four point rotating bending fatigue test machine at a frequency of 100 Hz. The tests were conducted at a zero mean load (i.e., a load ratio of  $R_L = -1$ , completely reversed load cycle) and stress amplitudes between 90 MPa and 125 MPa. The fracture surfaces after tensile and fatigue tests were examined using both stereo-microscopy and SEM techniques.

## RESULTS

### *Microstructure and Texture*

Fig. 2a illustrates typical SEM image with EDS analysis of both the matrix and prominent intermetallic present in AZ31B extruded magnesium alloy, also optical microscopy images of as-extruded and forged samples. It is seen in Fig. 2a that the AZ31B alloy contains Al-Mg-rich intermetallics. It is also evident that the as-extruded sample (Fig. 2b) possesses severely elongated grains whose major axis is oriented along the extrusion direction, and surrounded by bands of smaller grains. The calculated average grain size for the as-extruded material is 10  $\mu$ m with a significant bi-modal

size distribution. The forged specimens both exhibited a refinement in grain size, with little obvious effect of forging speed. In contrast, the forged samples exhibited an average grain size of 6.8  $\mu\text{m}$  and 6.9  $\mu\text{m}$  for the forging conditions of 10 mm/min (Fig. 2c) and 100 mm/min (Fig. 2d), respectively. The grain morphology in the forged conditions appears to be much more “pancake” like in nature.

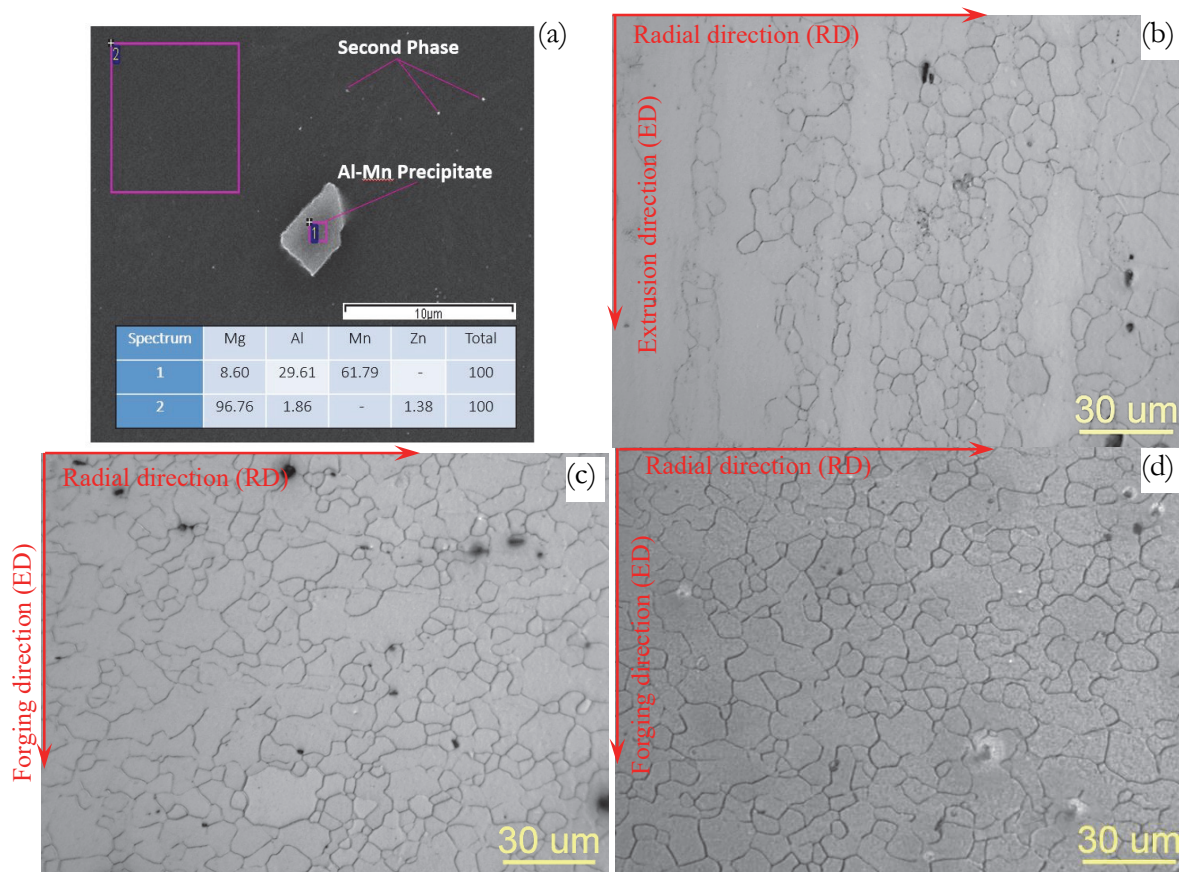

Figure 2: Microstructures of AZ31B alloy in different conditions, (a) typical SEM image with EDS analysis on matrix and prominent intermetallic and OM image of (b) as-extruded, and extruded followed by forging at 400°C temperature for the rate of (c) 10 mm/min (S1) and (d) 100 mm/min (S2).

Fig. 3 depicts the calculated pole figures for the basal (0001) and prismatic (10 $\bar{1}$ 0) planes obtained via XRD. There is a strong texture in the as-extruded condition (Fig. 3a) with the c-axis of the crystal orientated along the radial direction of the billet. The forged material however, exhibited a somewhat weaker texture, particularly in the prismatic plane, with its c-axis being reoriented to be coincident with the extrusion axis (forging direction).

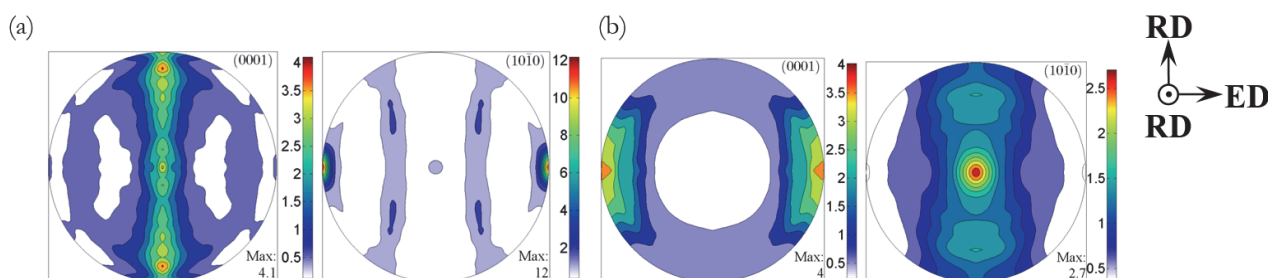

Figure 3: Calculated pole figure of AZ31B- extruded magnesium alloy in (a) as-extruded and (b) extruded followed by forging at a strain rates of 100 mm/min.



This effect of forging on the basal texture is a 90° rotation of the c-axis from the radial direction in the as-extruded condition to the direction of loading (extrusion axis) in all forgings. The rotation of the c-axis during compression of the extruded magnesium alloy was reported by several researchers in the literature [20, 3, 12]. Sarker and Chen [3] reported that after undergoing severe plastic deformation, the c-axes of AM30 extruded magnesium alloy were always rotated to be coincident with the loading direction. Furthermore, they also concluded that texture weakening occurred due to multidirectional loading.

### Tensile Properties

Fig. 4a shows the engineering stress-strain response for the as-extruded (base material) and forged (S1, S2) materials in the radial direction. It can be seen that once forged, the yield strength and elongation to failure significantly increase. A similar increase in yield stress in compression samples of AZ31B after forging was observed by Gryguc et al. [21]. This increase is attributed to the grain refinement and texture modification via the reorientation of the c-axis to the direction of forging. In addition, there is also a moderate increase in the ultimate tensile stress. Both the yield and ultimate strengths exhibit a positive correlation with increasing strain rate, whereas failure elongation decreases with higher strain rates. Fig. 4b illustrates the hardening behaviour for the investigated conditions. It can be observed that the base material is characterized by 3 distinct hardening response stages as described in [19] for AM30. For the base material, an initial rapid decrease in strain hardening rate up until a true stress of ~130 MPa was observed which was followed by stage 2 hardening where the rate stabilizes between ~130 MPa and 200 MPa. The final stage is a more moderate decrease in strain hardening rate until failure. In contrast, both forged samples (S1 and S2) exhibit only two distinct hardening response stages which are similar to stages 1 and 3 of the base material, however no rate stabilization similar to stage 2 was observed in the forged conditions. The presence of the hardening stabilization in stage 2 is an indicator of the occurrence of twinning deformation whereas the absence of the stabilization zone is indicative of slip deformation. The third stage shows almost identical hardening responses in all three conditions. Wang et al. [22] observed a similar hardening behaviour in compression for AZ31B normal to the extrusion direction with no stabilization in stage 2 except in the samples parallel to the extrusion direction.

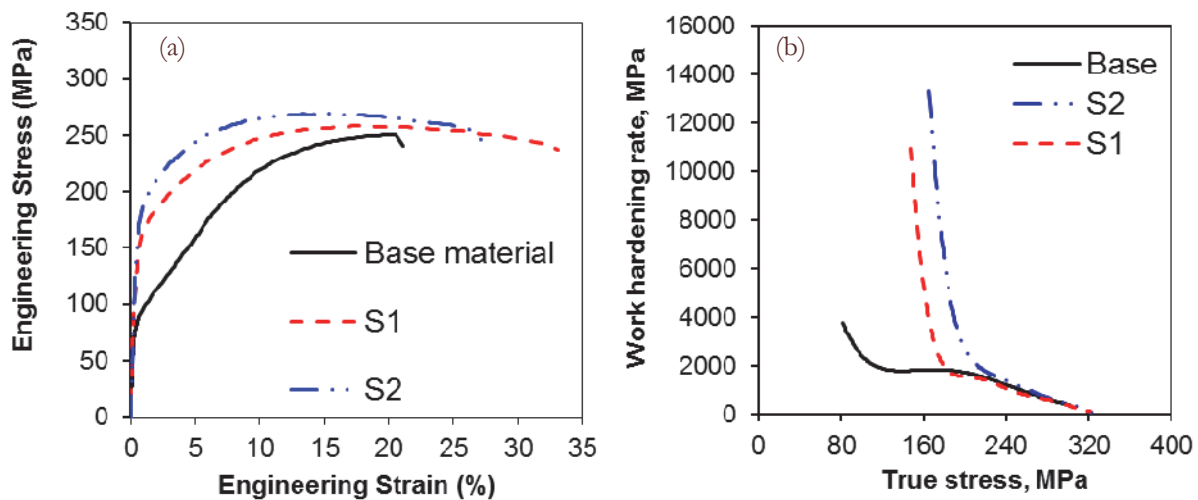

Figure 4: A comparison between base and forged conditions, (a) stress strain curves (b) and K-M plot of the base (as-extruded) and forged AZ31B magnesium alloy during tensile loading.

As discussed in an earlier section, the mechanical properties of magnesium alloy are significantly influenced by the texture, especially the orientation of the crystallographic c-axis relative to the loading direction of the material. At room temperature when the applied load is perpendicular to the c-axis, {10 2} extension twins are formed via a rotation of ~ 86.3° towards the loading direction, this results in a reduction of yield stress. The rotation of the c-axis and its inferred effect on the stress-strain response was explored by Gryguc et al. [21] where the compressive hardening response supports both the texture results and tensile hardening responses presented in this study. Their findings illustrated that in the extrusion direction, under monotonic compression, a shift from strong sigmoidal hardening behaviour in the as-extruded material to conventional monotonic hardening occurred once forged. Wang et al. [22] had found that following significant plastic strain, most c-axis orientations which are favourable for twinning will re-orient them to the compression direction.

### Fatigue Properties

Fig. 5 shows the S-N curve obtained from both the as-extruded and forged specimens up to  $\sim 10^7$  cycles. As seen in Fig. 5, the forged samples obtained significantly longer fatigue life for the fixed stress amplitude. In the mid to high cycle regime ( $>10^5$  cycles) the forged samples exhibited a significant improvement in S-N response, with an increase of  $\sim 35\%$  in fatigue strength for both forged conditions. At 120 MPa stress amplitude, the as-extruded alloy showed a fatigue life of  $\sim 10^4$  cycles while the sample forged at the rate of 100 mm/min (S2) exhibited a fatigue life of over  $10^7$  cycles. This is attributed to the forged material having a much larger elastic regime as compared to the as-extruded sample as discussed above. The fracture surface morphology, discussed below, also supports this observation.

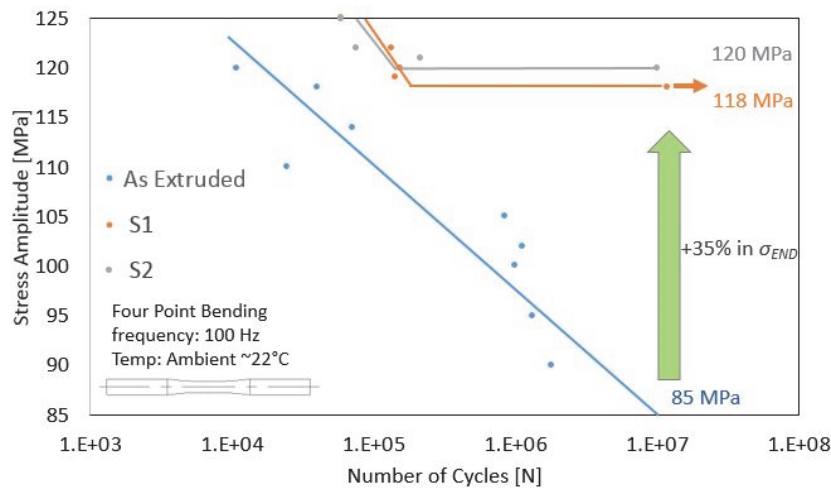

Figure 5: Fatigue life of forged AZ31B extruded magnesium alloy in comparison with the AZ31 extruded base alloy, obtained at total stress amplitudes of 90-125 MPa. Points with arrow show run-out tests.

Stereoscopic microscope images showing the macroscopic features of the fracture surface of the fatigue specimens are shown in Fig. 6. All samples exhibited fatigue crack initiation (FCI) at the surface of the specimen. The as-extruded material (Fig. 6a) exhibits a fracture surface with a very serrated and faceted morphology with a comparatively rough propagation zone relative to the forged samples (Fig. 6b) and (Fig. 6c). Both forged samples exhibited very similar characteristics in terms of their fatigue fracture surface, with a distinct FCI with radially branching fatigue striations and a large propagation zone which is much smoother than the as-extruded condition. The final fracture zone is opposite to the FCI location indicating a stable crack propagation perpendicular to the initial fatigue crack.

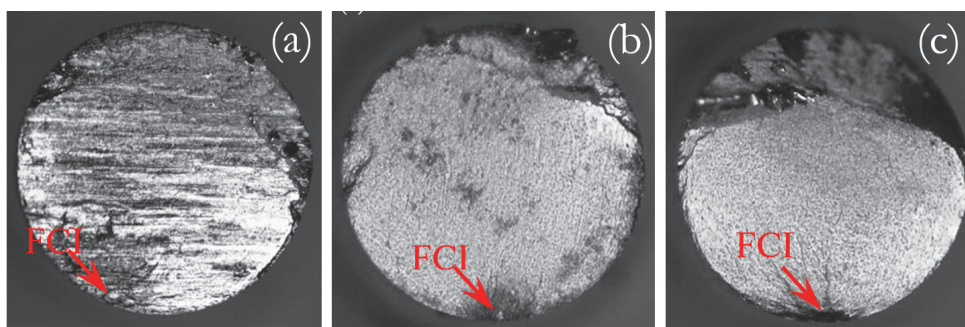

Figure 6: Stereoscopic microscope images showing an overall view of fatigue fracture surfaces of the samples tested at a total stress amplitude of 90 MPa (a) for the as-extruded sample, 120 MPa (b) and 125 MPa (c) for the forged sample. The red arrows indicate the crack initiation site. The fatigue cracks were initiated near the sample surfaces. FCI-fatigue crack initiation.

The propagation zone fracture surface morphology is shown in Fig. 7 (a, b). It can be seen that for the as-extruded material (Fig. 7a) the general direction of fatigue striations (FS) is in the transverse direction on the image (which is perpendicular to the crack propagation direction). All forged conditions (Fig. 7b) exhibit fatigue striations which, in general, spread in radial directions from the crack origin (longitudinally in the image). The final fracture zone surface morphology is shown in Fig. 7 (c, d). All conditions exhibit similar morphology to that of their monotonic tensile fracture

surface with the forged samples showing more evidence of ductile behaviour. The as-extruded material (Fig. 7c) shows characteristic terrace like structure with distinct facet-like features indicating locations of grain boundaries. In contrast, the forged samples (Fig. 7d) exhibit a very strong dimpled type morphology indicative of a ductile fracture surface supporting the longer fatigue life which was observed.

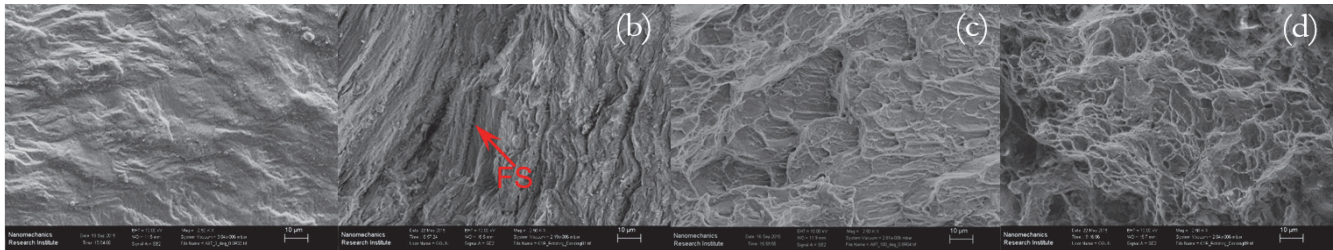

Figure 7: SEM images showing a comparison of crack propagation zone (a, b) and final fracture (c, d) between the as-extruded (a, c) and forged (b, d) of fatigue fracture surfaces tested at the total stress amplitude of (a) 90 MPa for the base sample, and (b) 120 MPa for the forged sample.

## CONCLUSIONS

The tensile and fatigue behavior in the radial direction of as-extruded and forged AZ31B magnesium alloy were investigated. On the basis of the microstructure, stress-strain response characteristics and fatigue behavior, the following conclusions can be drawn:

1. Microstructural analysis shows that AZ31B alloy in the as-extruded condition exhibited a significant bi-modal grain structure with average grain size of 10  $\mu\text{m}$  while the forged sample shows smaller, equi-axed grains with average grain size of about 6.8  $\mu\text{m}$ . At the same time, the plastic deformation imparted to the sample via forging resulted in both a weaker texture and a rotation of the crystal to align with the loading direction during forging.
2. The tensile tests showed that the AZ31B alloy in the forged condition had significantly higher yield strength and ductility in comparison with the AZ31B extruded alloy. It was observed that AZ31B alloy had a yield strength and failure elongation of about 81 MPa and 21% in as-extruded state while in the forged condition these properties improved to 168 MPa and 28% respectively.
3. The cyclic behaviour also showed a similar improvement in performance, i.e. longer fatigue life with an increase of 30 MPa in fatigue strength at  $10^7$  cycles being typical of the forged vs. as-extruded material. The improved fatigue performance in the forged samples was attributed to higher yield strength and increased ductility resulting from grain refinement and a modified texture.
4. The fracture surfaces of all samples were characterized by a terrace-like faceted morphology in the as-extruded condition, whereas the forged conditions exhibited a much more dimple-like fracture surface indicative of more plasticity.

## ACKNOWLEDGEMENT

The financial support of NSERC under automotive partnership Canada is gratefully acknowledged. All forging experiments were performed at CanmetMATERIALS. Both Multimatic Technical Centre and Ford Motor Company are gratefully acknowledged for their contributions.

## REFERENCES

- [1] Skaszek, T., Zaluzec, M., Conklin, J., Wagner, D., MMLV: Project Overview, SAE International, (2015).
- [2] Chen, X., Conklin, J. L., Carpenter, R. M., Wallace, J., Flanigan, C., Wagner, D. A., Kiridena, V., Betrancourt, S., Logsdon, J., MMLV: Chassis Design and Component Testing, SAE International, (2015).
- [3] Sarker, D., Friedman, J., Chen, D. L., Influence of pre-strain on de-twinning activity in an extruded AM30 magnesium alloy, *Materials Science and Engineering: A*, 605 (2014) 73-79.



- [4] Pan, H., Ren, Y., Fu, H., Zhao, H., Wang, L., Meng, X., Qin, G., Recent developments in rare-earth free wrought magnesium alloys having high strength: A review, *Journal of Alloys and Compounds*, 663 (2016) 321–331.
- [5] Fan, K. L., He, G. Q., Liu, X. S., Liu, B., She, M., Yuan, Y. L., Yang, Y., Lu, Q., Tensile and fatigue properties of gravity casting aluminum alloys for engine cylinder heads, *Materials Science and Engineering: A*, 78-85 (2013) 586.
- [6] Somekawa, H., Maruyama, N., Hiromoto, S., Fatigue Behaviors and Microstructures in an Extruded Mg-Al-Zn Alloy, *Materials Transactions*, 49 (2008) 681-684.
- [7] Yin, S. M., Yang, F., Yang, X. M., Wu, S. D., Li, S. X., Li, G. Y., The role of twinning–detwinning on fatigue fracture morphology of Mg–3%Al–1%Zn alloy, *Materials Science and Engineering A*, 494 (2008) 397-400.
- [8] Xu, D. K., Liu, L., Xu, Y. B., Han, E. H., The crack initiation mechanism of the forged Mg–Zn–Y–Zr, *Scripta Materialia*, 56 (2007) 1-4.
- [9] Kalateh, E., Mahmoudi-Asl, H., Jahed, H., An asymmetric elastic–plastic analysis of the load-controlled rotating bending test and its application in the fatigue life estimation of wrought magnesium AZ31B, *International Journal of Fatigue*, 64 (2014) 33-41.
- [10] Marzban, B., Toyserkani, E., Jahed, H., Applications of FBG Sensors to Strain Measurements of AZ31B Extrusion in Rotating Bending Test, in 25th CANCAM, London, Ontario, Canada, (2015).
- [11] Albinmousa, J., Jahed, H., Lambert, S., Cyclic Behaviour of Wrought Magnesium Alloy under Multiaxial Loading, *International Journal of Fatigue*, 33 (2011) 1403-1416.
- [12] Albinmousa, J., Jahed, H., Multiaxial Effects on LCF Behavior and Fatigue Failure of AZ31B Magnesium Extrusion, *International Journal of Fatigue*, 64 (2014) 103-116.
- [13] Albinmousa, J., Jahed, H., Lambert, S., Estimation of Fatigue Crack Orientation using Critical Plane Parameters: An Experimental Investigation," in ICMFF10, Kyoto, Japan, (2013).
- [14] Albinmousa, J., Jahed, H., Lambert, S., An energy-based fatigue model for wrought magnesium alloy under multiaxial load," in 9th International conference on multiaxial fatigue and fracture, Parma, Italy, (2010).
- [15] Jahed, H., Albinmousa, J., Multiaxial Behaviour of Wrought Magnesium Alloys–A Review and Suitability of Energy-Based Fatigue Life Model, *Theoretical and Applied Fracture Mechanics*, 73 (2014) 97-108.
- [16] Tokaji, K., Kamakura, M., Ishiizumi, Y., Hasegawa, N., Fatigue behaviour and fracture mechanism of a rolled AZ31, *International Journal of Fatigue*, 26 (2004) 1217-1224.
- [17] Morita, N. O. S., Fatigue properties of rolled AZ31B magnesium alloy plate, *Trans. Nonferrous Met. Soc. China*, (2010) s523-s526.
- [18] Albinmousa, J., Jahed, H., Lambert, S., Cyclic Axial and Cyclic Torsional Behaviour of Extruded AZ31B Magnesium Alloy, *International Journal of Fatigue*, 33(8) (2011) 1127-1139.
- [19] Sarker, D., Chen, D. L., Detwinning and strain hardening of an extruded magnesium, *Scripta Materialia*, 67 (2012) 165-168.
- [20] Sarker, D., Chen, D. L., Texture transformation in an extruded magnesium alloy under pressure, *Materials Science and Engineering: A*, 582 (2013) 63-67.
- [21] Gryguc, A., Jahed, H., Williams B., McKinley, J., MagForge – Mechanical Behaviour of Forged AZ31B Extruded, *Materials Science Forum*, 828-829 (2015) 291-297.
- [22] Wang, B., Xin, R., Huang, G., Liu, Q., Effect of crystal orientation on the mechanical properties and strain hardening, *Materials Science and Engineering A*, 534 (2011) 588-593.