

## Performance Study of Electrodialysis for Treatment Fuel Washing Wastewater

Basma A. Abdul Majeed<sup>1</sup> and Maitham Adham Zubaidy<sup>2</sup>

<sup>1</sup>Chemical Engineering Department-College of Engineering-University of Baghdad-Iraq

<sup>2</sup>Department of Environment-Ministry of Industry and Minerals-Iraq

### Abstract

In this work, electrodialysis (ED) has been demonstrated to be appropriate technique for reducing the electrical conductivity of real wastewater from fuel washing unit, which has been previously treated by other electrochemical technology (electrocoagulation and electrooxidation). A five cell electrodialysis stack, with an active membrane area of 60 cm<sup>2</sup> per cell was employed. During a batch recirculation mode ED system, the effects of parameters such as electrical potential applied (6-18 V) and flow rate of streams (0.5-1.7 L/min.) on the performance of the total dissolved solids (TDS) separation and specific power consumption (SPC) were studied. The results indicate that the process of ED under potential (15 V) and flow rate (1.4 L/min) are recommended as operation conditions. The removal of TDS achieved was about 95% throughout (80 min.) time of electrodialysis and (1.72 kWh/m<sup>3</sup>) of SPC. Moreover, SPC increased with an increase in the applied potential of ED stack, while it was not intensely responsive to the change in the flow rate.

**Key words:** Electrodialysis, Real wastewater, Fuel washing, Ion exchange membrane.

### Introduction

Water is a critical necessity for utilization of humanity. It is crucial for rural and modern development, and also to support developing populaces that requires a harmless drinking water supply [1].

Water requirements are expanding quickly and thus the accessibility of good water sources is being brought down. Consequently, the reclamation and reuse of treated urban wastewaters is turning into an attractive study subject for tending to water lack. Desalination is a process that removes dissolved minerals from

brackish water, sea water or treated wastewater [2]. There are essentially two groups of desalination innovations utilized all through the world today. These incorporate thermal technologies and membrane technologies. Thermal processes are those that evaporate water and gather condensed vapor to create distilled water. Infrequently, evaporation procedures are utilized to desalinate brackish water, as it is uneconomic for this purpose.

Membrane technologies are much modern innovation than thermal procedures. It utilizes membranes to separate the inlet solution into two

different solutions which are called product and concentrate. Reverse osmosis (RO) and electrodialysis (ED) are considered primarily membrane processes for desalination [3].

Electrodialysis procedure is more cost effective than reverse osmosis for desalination of the wastewater which contains TDS of 500 - 4000 ppm, thus, ED is generally utilized for desalination of industrial wastewater containing TDS of 500 ~ 1500 ppm [4].

The reclamation and reuse of wastewater by ED was widely reported in publications like in almond industry [5], wastewater plant [6] brine from a reverse osmosis [7] and nuclear power plant [8].

ED is an electrochemical separation process in which ions are traveled through ion exchange membranes by effects of a constant current or potential. Potential driving force is utilized to transfer dissolved ions from the feed water through cationic and anionic exchange membranes to form a concentrate and dilute streams [9].

An electrodialysis (ED) unit is made out of alternating anion and cation membrane sheets inserted between cathode and anode electrodes, these membrane sheets are separated from each other by spacers. Ionic species are depleted from dilute cells and collected in concentrate cells.

Generally, several factors can affect the ED process performance such as stack design, length of the solution path in the stack, number of cells, feed concentration, flow rate and applied voltage, etc. [10, 11].

In this work, electrodialysis is proposed to be the procedure used for decreasing electrical conductivity by removing TDS from a real fuel oil washing wastewater (FWW) obtained from gas power station and pretreated

by in situ electrocoagulation-electrooxidation method.

The aims of this work are to show that ED is an appropriate method for desalting fuel washing wastewater which is previously treated by other electrochemical techniques. The effect of applied potential and feed flow rate on the TDS removal efficiency has been studied to investigate the best conditions for the treatment at laboratory level.

## Materials and Method

### 1. ED Set Up

The ED setup consisted of: DC power supply (UNI-T, model: UTP3315FT-L), three glass tank each of 2 L was used for concentrate, feed (dilute) and electrode rinse, three diaphragm pumps (type HF-9050, Taiwan) equipped each with a flow meter, three pressure gauges (0-2.5 bar) to maintain the similar pressure drop across compartments. Three valves were used to control solutions flow rate in the concentrate, dilute and electrodes compartments of ED cell. Figure 1 shows a simplified diagram of the ED setup working in batch recirculation mode.

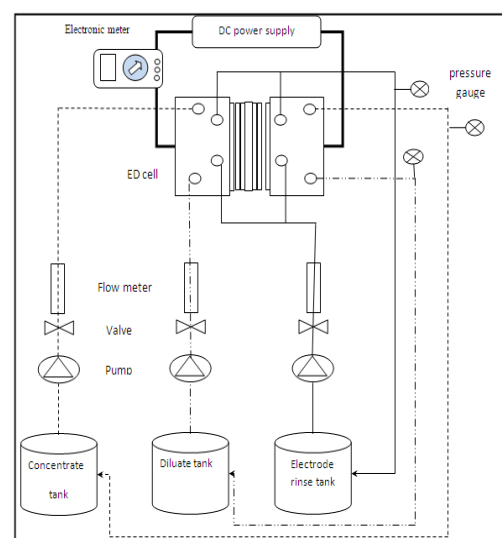

Fig. 1: The ED experimental setup

## 2. Cell and Membranes

The electro dialysis cell employed at present work was homemade designed and manufactured based on the research studies in the field of lab electro-membrane processes. The ED stack packed with five pair cells of cation and anion exchange membranes. Plastic spacers with 0.5 mm were placed between the membranes to form the flow paths of the dilute and concentrate streams.

These spacers were designed to minimize boundary layer effects and were arranged in the stack so that all the dilute and concentrate streams were manifold separately. In this way a repeating section called a pair cell was formed; it consisted of a cation exchange membrane, a dilute flow spacer, an anion-exchange membrane, and a concentrate flow spacer. In this work, experiments were carried out by this stack equipped with six cation exchange membranes (CEM) and five anion exchange membranes (AEM) arranged as described in Figure 2.

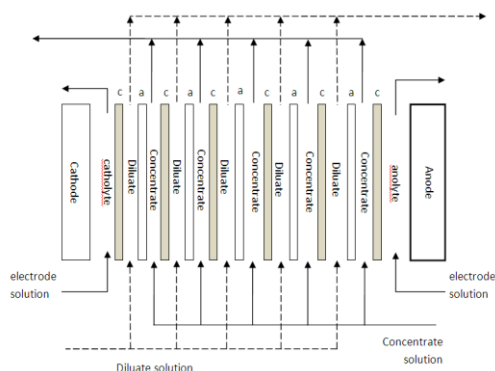

Fig. 2: The ED stack configuration

Membranes used in these experiments were (anion AR204SXR412) and (cation CR67, MK111) manufactured by Ionics, Watertown, MA, USA. Table 1 shows the main characteristics of the membranes, according to the data provided by the supplier (membranes were supplied from Aldora refinery, Iraq).

Table 1: Characteristics of the membranes

Property	Membrane	
	AR204SXR412	CR67,MK111
Reinforcing fabric	Acrylic	Acrylic
Specific weight mg/cm <sup>2</sup>	13.7	13.7
Thickness mm	0.5	0.56-0.58
Burst strength kg/cm <sup>2</sup>	7	7
Capacity meq/g	2.8	2.4
Chemical stability pH	1-10	1-10

The active membrane area was 60 cm<sup>2</sup> per cell, thus the total active area of the stack was 300 cm<sup>2</sup>. Stainless steel (316 L) and graphite were selected as cathode and anode electrodes respectively.

Area of each electrode was 6 cm×10 cm with a thickness of 0.3 cm. Thickness of dilution and concentrate cell were 0.15 cm with 0.6 cm<sup>2</sup> cross sectional area of flow for each. Cathode and anode distances were 4 mm from membrane in catholyte and anolyte compartments.

## 3. Materials

Sodium chloride (NaCl) with purity (99.5% wt.), product of Fisher chemicals (USA) was used to prepare concentrate solution at appropriate electrical conductivity. Sodium sulphate (Na<sub>2</sub>SO<sub>4</sub>) with purity (99.5% wt.), product of Fisher chemicals (USA) was used to prepare rinse 0.5 M solution.

## 4. Analytical Method

In all experiments, ion conductivity meter (CRISON Basic-30, Spain), was used to measure the ionic concentration, TDS and conductivity of the solution during the experiments. Pros Kit MT 1210 avometer was used to measure current passed through the ED stack circuit.

## 5. Characterization of Wastewater

The source of wastewater for the ED was a real fuel oil washing wastewater (FWW) obtained from the South Baghdad gas power station/2 and pretreated by electrocoagulation-electrooxidation in situ method at the best investigated conditions. About 20 liters of pretreated FWW were produced and collected to be post treated by desalination in ED experiments. The main characteristics of the real and pretreated FWW are shown in Table 2.

Table 2: Characteristics of pretreated FWW

Parameter	Real	Pretreated
pH	6.5-7.3	6.15
Turbidity (NTU)	785	24.3
TSS (mg/L)	488	34
Oil content (mg/L)	586	1.1
Conductivity ( $\mu\text{S}/\text{cm}$ )	2350-2550	1722-1751
COD (mg/L)	753-760	72-79
TDS (mg/L)	1370	907-923

## 6. Experimental Method

In each experiment, the solutions employed were 1L of the wastewater (pretreated FWW) as a dilute, 1L of NaCl 895 mg/L (about 1700  $\mu\text{S}/\text{cm}$  electrical conductivity) as a concentrate and 2L of  $\text{Na}_2\text{SO}_4$  (0.5 M) as the electrolyte solution. In order to study the voltage effect on the ED process, a series of potentiostatic experiments with voltage range of (6, 9, 12, 15 and 18 V) were carried out with fixed flow rate of 0.5 L/min for dilute and concentrate solutions. In order to study the flow rate effect on the ED process, several tests at the best selected voltage were approved with a wide flow rate range (0.5, 0.8, 1.1, 1.4 and 1.7 L/min.) The TDS concentration of salts as well as the conductivity of dilute and concentrate solutions were measured at 10 min. intervals, also the electrical current of the ED stack was recorded during the

electrodialysis time. The time of treatment for each experiment was 60 minutes. The flow rate of the electrolyte solution was fixed at 1.2 L/min for all experiments. Moreover, pressure drop was maintained the same for all solution streams in each case.

In this study, the quality characteristic was the separation percentage (SP) which was calculated as follows:

$$SP(\%) = \left(1 - \frac{C_t}{C_i}\right) \times 100 \quad \dots(1)$$

Where,  $C_t$  and  $C_i$  are timed and initial ionic salts concentrations (mg/l), respectively.

Also, Specific power consumption (SPC) is an important parameter from the economical point of view, as it can be described as the energy consumed for desalting one  $\text{m}^3$  of feed solution and it is calculated here as electrical energy consumed only in the cells ( $\text{kWh}/\text{m}^3$ )

$$SPC = \frac{E \int_0^t I dt}{1000 * V_d} \quad \dots(2)$$

Where E is the applied potential (volt), I is the current (ampere),  $V_d$  is the dilute stream volume ( $\text{m}^3$ ), and t is the time (hour) [12].

## Results and Discussion

### 1. Effect of Applied Voltage

The treated FWW by EC-EO was further reclaimed by electrodialysis (ED) process in order to recycle and reuse water in the washing fuel system. The separation performance of dissolved salts from the treated FWW was investigated at constant voltage electrodialysis experimental studies through an unsteady state batch recycled run of the ED system. At time intervals of 10 min, both TDS concentrations and electrical conductivity of concentrate

stream (C) and dilute stream (D) were measured.

The operating time for each run was fixed at time (60 min.) while the flow rate was set at (0.5 L/min). Different voltages values (6,9,12,15 and 18 V) were tested. The conductivity of concentrate and dilute streams versus time at different voltages was plotted as shown in Figure 3. It can be noticed from Figure 3 that the conductivity of both dilute and concentrate streams were varying with different voltages. The conductivity of dilute stream decreased faster with increasing applied voltages which means higher transfer rate and lower duration time was needed to achieve a particular target at greater potential driving force. On the other hand, the slop of conductivity curves for concentrate stream was increased with increasing the applied voltage as consequence of mass balance of the transferred salts.

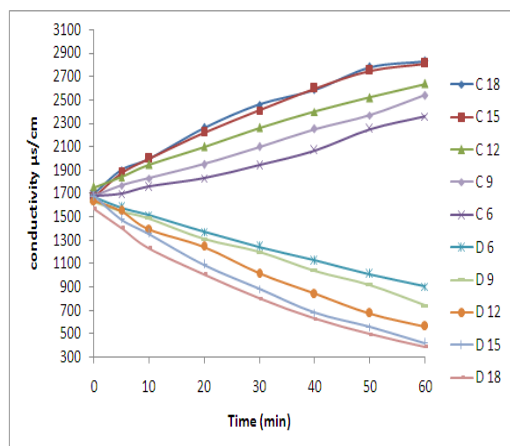

Fig. 3: Curves of conductivity of dilute (D) and concentrate (C). vs. time at different voltages and constant flow rate (0.5 L/min.)

Same conductivity behavior were illustrated by Valero et al [5] who studied the application of electro dialysis for the treatment of almond industry wastewater. The TDS removal efficiency of the dilute stream against time at different voltages was plotted in Figure 4. It can be shown from Figure 4 that the TDS removal

efficiency (SP) was increased with increase of electrical potential. At 60 min. of the process, the removal was 45.8% at 6 volte while it were 74.93% and 75.2% at 15 and 18 voltages respectively. The convergence between two last curves may be attributed to approaching close the limiting current density of the ED process [13].

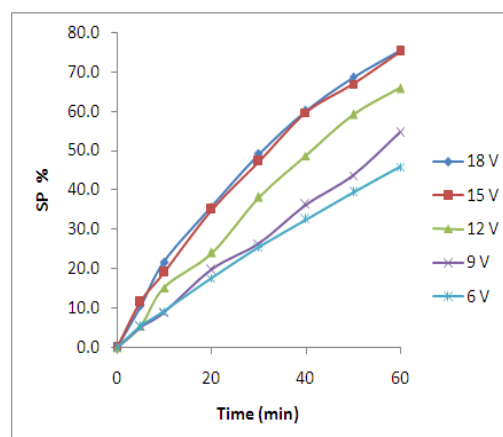

Fig. 4: TDS removal efficiency of dilute stream against time at flow rate 0.5 L/min. and different voltages range

## 2. Effect of Flow Rate

From economical point view, applied voltage (15 V) was selected to examine the effect of flow rate on the separation performance. At constant voltage, various flow rates (0.5, 0.8, 1.1, 1.4 and 1.7 L/min) were tested. The conductivity of concentrate and dilute streams versus time at different flow rates was plotted in Figure 5.

Figure 5 shows that the conductivity of dilute decreased while the conductivity of concentrate increased with the increasing flow rate. The TDS removal efficiency (SP) of the dilute stream against time at different voltages was plotted in Figure 6.

It can be shown from Figure 6 that the TDS removal efficiency was increased with increasing of flow rate. After 60 min. of the process, the removal was 74.93% at flow rate (0.5 L/min) while it was achieved 90.8% and 92.5% at 1.4 and 1.7 L/min



respectively. Increasing the flow rate leads to increasing the linear velocity of solution across the membrane surface, which results in decreasing the boundary layer thickness and improving the mass transfer coefficient. Unless, in high flow rate the decrease of residence time in cells offsets the positive effect of layer thickness decrease. This behavior was reported as well by Gangchoon Lee [14].

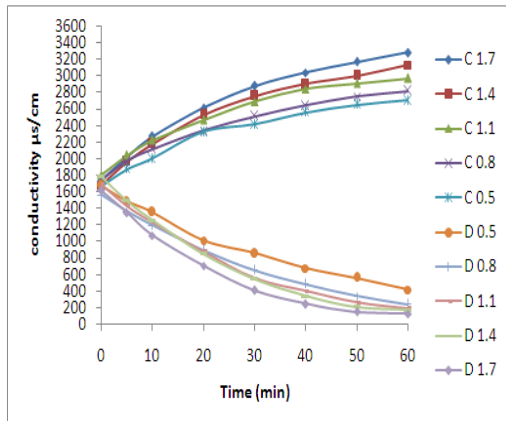

Fig. 5: Curves of conductivity of dilute (D) and concentrate (C). vs. time at different flow rates and constant voltage (15 V)

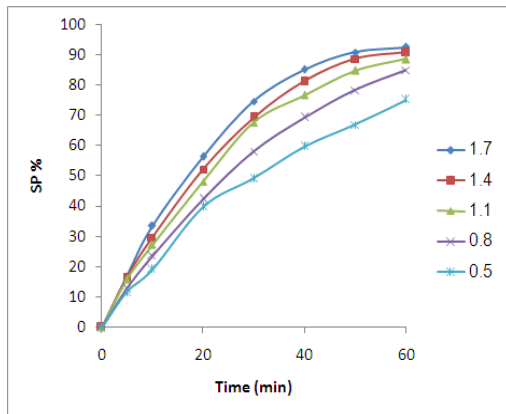

Fig. 6: TDS removal efficiency of dilute stream against time at applied voltage (15 V) and different flow rates range

### 3. Specific Power Consumption

For each set of potential and flow rate experiments, the specific power consumption ( $\text{kWh/m}^3$ ) was estimated based on Equation 2. The calculated SPC was plotted in Figure 7 for both potential and flow rate experiments.

It can be seen from Figure 7-a that the SPC was drastically affected by the change in the applied potential force and the voltage line was extended for a wide range of SPC ( $0.287\text{-}1.94 \text{ Kw h/m}^3$ ).

In contrast, the SPC has negligible changes with flow rate chosen and the flow rate line has small range ( $1.39\text{-}1.69 \text{ Kw h/m}^3$ ) in SPC scale as illustrated in Figure 7-b. Therefore it can be concluded that voltage has the higher effect on the SPC rather than the flow rate. This behavior was also observed by Demircioglu et al.[15] and Kabay et al.[16].

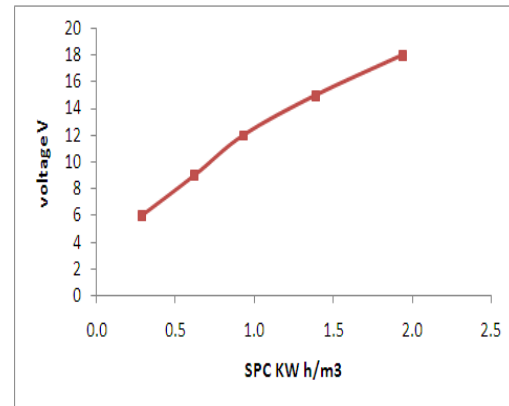

(a)

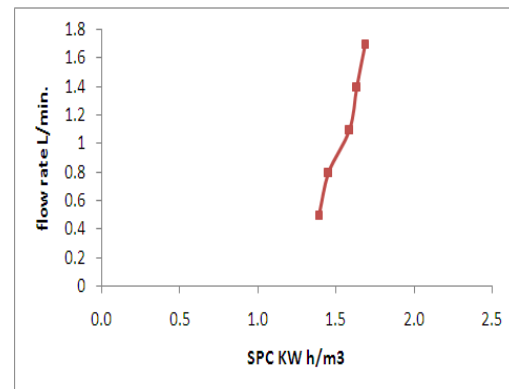

(b)

Fig. 7: the SPC for (a) different potential (at flow rate =  $0.5 \text{ L/min.}$ ) and (b) different flow rate (at potential = 15 volts)

It can be seen that the best conditions of ED process which give the higher TDS removal at acceptable SPC and were 15 V and 1.4 L/min.

To investigate the possibility of achieving higher removal with increasing time, an experiment was conducted at the optimum conditions along with electro dialysis process time as shown in Figure 8.

The ED stack operated under potential of 15 V and the flow rate of 1.4 L/min was able to remove about 95% of TDS removal and reduces the dilute solution conductivity value from 1538  $\mu\text{S}/\text{cm}$  to 67  $\mu\text{S}/\text{cm}$  during 80 min of operation time with about 1.72  $\text{kWh}/\text{m}^3$  of SPC. It is clear that increasing time higher than 80 min has no effect on the removal efficiency and leading to dissipate the energy used for the system with marginal increment of removal efficiency.

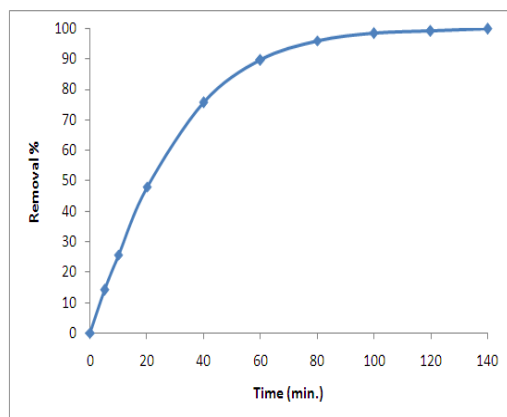

Fig. 8: TDS removal at voltage 15V, flow rate 1.4 against time

## Conclusions

A laboratory study was conducted to investigate the feasibility of electro dialysis process for treating the electrochemically pretreated fuel washing wastewater containing TDS concentration about 923 ppm.

Removal efficiency was increased with the applied potential in the range 6-18 V due to strength of electrical potential as driving force for mass transfer. However, the increment of removal efficiency was diminished as the applied potential increases.

Removal efficiency in dilute was enhanced with flow rate in the range of

0.5-1.7 L/min due to the positive effect on removal rate of salts ion as a result of reducing the boundary layer thickness and improving the mass transfer coefficient. The inconsequential increment of removal rate higher than 1.4 L/min was come about because of the decline of residence time in cells.

Based on the operation of the electro dialysis stack used in this work, the applied voltage 15 V and the flow rate of 1.4 L/min are recommended as suitable operating conditions for wastewater solutions which corresponds to about 95% of TDS removal and reduces the dilute solution conductivity around 23 times in 80 min of operation time.

It was obtained that the specific power consumption (SPC) was influenced by the potential applied. While it was not intensely responsive to the change in flow rate.

## References

1. Mohtada Sadrzadeh, Toraj Mohammadi, (2009), "Treatment of sea water using electro dialysis: Current efficiency evaluation", *Desalination*, 249, 279–285.
2. Mohtada Sadrzadeh, Toraj Mohammadi, (2008), "Sea water desalination using electro dialysis", *Desalination*, 221, 440–447.
3. Mourad Ben Sik Ali, Amine Mnif, Bechir Hamrouni, Mahmoud Dhabbi, (2009), "Desalination of brackish water using electro dialysis: Effect of operational conditions", *Zastita Materijala*, 50, 141-146.
4. K Sato, S. Kobayashi and S. Okado, (1983), "Desalination and Reuse of Industrial Waste Water by Electro dialysis", *Desalination*, 47, 363–373.
5. David Valero, Vicente García-García, Eduardo Expósito, Antonio Aldaz, Vicente Montiel, (2015), "Application of electro dialysis for

- the treatment of almond industry wastewater", Journal of Membrane Science, 476, 580–589.
6. Lute Broens, Nick Liebrand, Harry Futselaar, Juan Carlos de Armas Torrent, (2004), "Effluent reuse at Barranco Seco (Spain): a 1,000 m<sup>3</sup>/h case study", Desalination, 167, 13-16.
  7. Mohammad Badruzzaman, Joan Oppenheimer, Samer Adham, Manish Kumar, Innovative beneficial reuse of reverse osmosis concentrate using bipolar membrane electrodialysis and electrochlorination processes, Journal of Membrane Science 326 (2009) 392–399.
  8. Kyeong-Ho Yeon, Jung-Hoon Song, Joonmok Shim, Seung-Hyeon Moon, Yeon-Uk Jeong, Hyo-Young Joo, (2007), "Integrating electrochemical processes with electrodialysis reversal and electro-oxidation to minimize COD and T-N at wastewater treatment facilities of power plants", Desalination, 202, 400–410.
  9. Fernando Valero, Angel Barceló and Ramón Arbós. (2011), "Electrodialysis Technology - Theory and Applications", Desalination, Trends and Technologies, Michael Schorr Ed.
  10. Natalia Kaňavova, Lubomir Machuča, David Tvrznik, (2014), "Determination of limiting current density for different electrodialysis modules", Chemical Papers, 68, 324–329.
  11. Zaheri, A. Moheb, A. R. Keshtkar, A. S. Shirani, (2010), "Uranium Separation from Wastewater by Electrodialysis", Iran. J. Environ. Health. Sci. Eng., 5, 7, 429-436.
  12. N. Kabay, M. Yüksel, S. Samatya, Ö. Arar and Ü. Yüksel, (2006), "Effect of Process Parameters on Separation Performance of Nitrate by Electrodialysis", Separation Science and Technology, 41, 3201–3211.
  13. Farrell S., Hesketh R. P. and Slater C. S., (2003), "Exploring the Potential of Electrodialysis", Chemical Engineering Education, Rowan University • Glassboro, NJ 08028, pp 52-59.
  14. Gangchoon Lee, (2011), "Effects of operating parameters on the removal performance of electrodialysis for treating wastewater containing cadmium", Desalination and Water Treatment, 35, 150–157.
  15. M. Demircioglu, N. Kabay, E. Ersoz, I. Kurucaovah, C. Safak, N. Gizli, (2001), "Cost comparison and efficiency modeling in the electrodialysis of brine", Desalination 136, 317-323.
  16. N. Kabay, M. Demircioglu, E. Ersöz, I. Kurucaovali, (2002), "Removal of calcium and magnesium hardness by electrodialysis", Desalination 149 343–349.