

# Development of lower-limb rehabilitation exercises using 3-PRS Parallel Robot and Dynamic Movement Primitives

Rafael J. Escarabajal<sup>1</sup>, Fares J. Abu-Dakka<sup>2</sup>, José L. Pulloquina<sup>1</sup>,  
Vicente Mata<sup>3</sup>, Marina Vallés<sup>1</sup>, Ángel Valera<sup>1</sup>

<sup>1</sup>Instituto de Automática e Informática Industrial, Universitat Politècnica de València – Camino de Vera s/n, 46022 – Valencia, Spain

<sup>2</sup>Department of Electrical Engineering and Automation (EEA), Aalto University, Espoo, Finland

<sup>3</sup>Centro de investigación de Ingeniería Mecánica (CIIM). Universitat Politècnica de València – Camino de Vera s/n, 46022 – Valencia, Spain

Corresponding author: Rafael J. Escarabajal, e-mail address: [raessan2@upv.es](mailto:raessan2@upv.es)

Received: 03 June 2020; Accepted: 04 September 2020; Published: October 2020

---

## Abstract

The design of rehabilitation exercises applied to sprained ankles requires extreme caution, regarding the trajectories and the speed of the movements that will affect the patient. This paper presents a technique that allows a 3-PRS parallel robot to control such exercises, consisting of dorsi/plantar flexion and inversion/eversion ankle movements. The work includes a position control scheme for the parallel robot in order to follow a reference trajectory for each limb with the possibility of stopping the exercise in mid-execution without control loss. This stop may be motivated by the forces that the robot applies to the patient, acting like an alarm mechanism. The procedure introduced here is based on Dynamic Movement Primitives (DMPs).

**Keywords:** Parallel robot, rehabilitation robot, Dynamic Movement Primitives, position control

---

## 1. Introduction

Parallel robots are made up of closed kinematic chains that connect a fixed platform with a mobile one, which usually includes the end effector. Comparing to a Serial Robot, a Parallel Robot (PR) has better precision and dynamic performance, providing many applications such as rehabilitation, manufacturing, etc. (Patel & George, 2012). In this paper, we focus on medical rehabilitation applications, which are intended to aid injured patients. Many applications of robotics for rehabilitation can be found in (Xie, 2016), and lower limb rehabilitation devices are discussed in (Díaz et al., 2011). This subfield includes gait trainers (Hesse & Uhlenbrock, 2000; Reinkensmeyer et al., 2006) and ankle rehabilitation (Dai et al., 2004; Liu et al., 2006; Sui et al., 2009).

In the context of sprained ankle rehabilitation, the aim of the robot is to imitate and adjust the exercises done by the patient. Control strategies for this kind of applications can be found in (Saglia et al., 2013; Tsoi et al., 2009). Many problems related to singular configurations can be found during the design of a PR (Gosselin & Angeles, 1990), so techniques like robot limb reconfiguration are arising in order to widen the range of movements required to run the exercise (Yoon et al., 2006).

In this paper, a 3 DoF PR is proposed to carry out the desired movements for the ankle; the first degree of freedom allows dorsiflexion/plantarflexion movements, the second permits inversion/eversion (Brockett & Chapman, 2016), and the third is translational and allows the physical ascent and descent of the limb according to the height of the patient.

In addition to the suitable kinematic and dynamic model of the robot, which is described in the Section 2, a position control system based on Dynamic Movement Primitives (DMPs) is provided (Ijspeert et al., 2013; Schaal, 2006). This approach converts the time variable into a manipulable variable called phase, and its application cover several intelligent robotics applications, such as humanoid robots (Ijspeert et al., 2002) and biped locomotion (Nakanishi et al., 2004).

DMPs encode the time-dependent reference trajectories to a phase-dependent and nonlinear system which is the actually followed. The phase variable can be manipulated to slow down and adapt the exercise or simply stop it, providing more flexibility, and so there is no need to accurately design a trajectory for every situation. Conversely, having a finite set of trajectories and adapting them according to some parameters tuned offline or online is viable, thus generating a training and

learning environment (Nemec & Ude, 2012). This can be customized to each patient with the help of medical personnel. The DMP system is an approximation that can be optimized using locally weighted regression (Atkeson et al., 1997) or Gaussian Process Regression (Fanger et al., 2016).

Specifically, DMPs are used in this paper with two purposes: 1) to encode the predefined references in the cartesian space by the medical personnel, and 2) to stop the execution of an unfinished exercise keeping the control of the robot in the final position, and being able to resume the exercise from the last point if needed. This application emulates an alarm mechanism.

The paper is structured as follows: Section 2 presents the kinematic and dynamic model of the robot, Section 3 describes the DMP system regarding the trajectory generation and phase stopping, Section 4 includes the control scheme with the proposed approach, Section 5 presents an application of the system on a lower-limb rehabilitation exercise, and Section 6 expounds the conclusions.

## 2. Kinematic and dynamic model of the 3 DoF Parallel Robot

The rehabilitation exercises are performed in a 3 DoF PR (see Figure 1a). It was developed at Universitat Politècnica de València (Vallés et al., 2012), and consists of three kinematic chains (legs) which enable two angular rotations (roll and pitch) and a linear motion (heave). Each limb has a ball screw actuator as a prismatic joint (P) and an intermediate coupling bar to connect to the mobile platform. The bar is connected to the actuator with a revolute joint (R), and to the mobile platform with a spherical joint (S). The limbs are arranged in equilateral triangular configuration (Figure 1b).

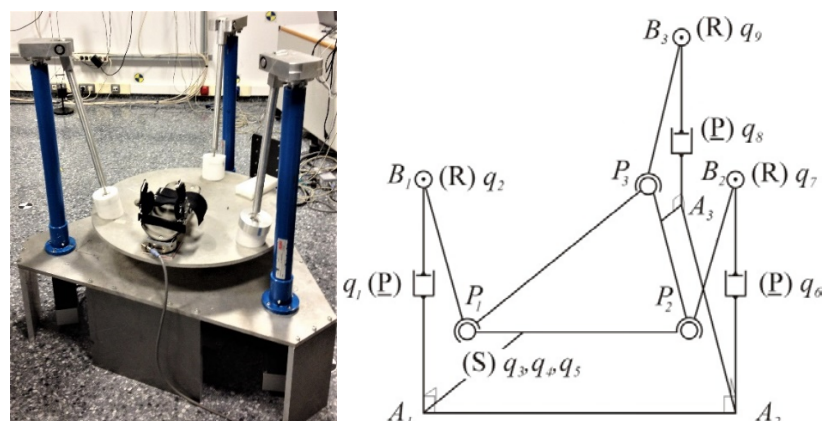

**Figure 1.** (a) The 3-PRS Parallel Robot; (b) Kinematic diagram, joints and generalized coordinates.

The active (i.e., actuated) generalized coordinates  $q_1$ ,  $q_6$  and  $q_8$  correspond to the prismatic joints;  $q_2$ ,  $q_7$  and  $q_9$  are the passive generalized coordinates associated with the revolute joints (R), and the coordinates  $q_3$ ,  $q_4$  and  $q_5$  represent the spherical joint (S). The inverse kinematic model to get the actuated coordinates is obtained by applying Denavit-Hartenberg parameters based on Paul's notation (Paul, 1981) and geometric constraints. The forward kinematic model uses the Newton-Raphson method to get  $q_2$ ,  $q_7$  and  $q_9$ , for a given position and orientation of the mobile platform:

$$\begin{bmatrix} q_2 \\ q_7 \\ q_9 \end{bmatrix}^{i+1} = \begin{bmatrix} q_2 \\ q_7 \\ q_9 \end{bmatrix}^i - J_i^{-1} \begin{bmatrix} f_1(q_2, q_7) \\ f_2(q_2, q_9) \\ f_3(q_7, q_9) \end{bmatrix}^i \quad (1)$$

In the equation (1),  $J_i$  is the Jacobian Matrix of  $f_i$  with respect to the variables  $[q_2 \ q_7 \ q_9]$ , and  $f_i$  considers the geometrical constraints among the variables (Vallés et al., 2012).

Regarding the PR dynamics, when independent generalized coordinates are used to model the PR, the equation of motion can be expressed as follows,

$$M(\vec{q})\ddot{\vec{q}} + \vec{C}(\vec{q}, \dot{\vec{q}})\dot{\vec{q}} + \vec{G}(\vec{q}) = \vec{\tau} \quad (2)$$

where  $M$  is the system mass matrix,  $\vec{C}$  is the matrix which includes the centrifugal and Coriolis terms,  $\vec{G}$  is a vector that contains the gravitational terms and  $\vec{\tau}$  is the vector of generalized forces. An exhaustive dynamic model identification of the robot can be found in (Díaz-Rodríguez et al., 2010).

### 3. Dynamic Movement Primitives

This Section describes the two utilities covered by the DMP system, as mentioned earlier: firstly, the reference trajectory generation in the phase-domain from the time-domain, which is provided by the physiotherapist, and secondly, the possibility of stopping the exercise in mid-execution.

#### 3.1. Trajectory adaptation using DMP

The trajectories designed by the medical personnel for the exercises are periodic, so a rhythmic DMP variant suits well for this problem, which encodes the trajectories by means of the following nonlinear equations (A. J. Ijspeert et al., 2013):

$$\tau \dot{z} = \alpha_z(\beta_z(g - y) - z) + f(\phi, r) \quad (3)$$

$$\tau \dot{y} = z \quad (4)$$

$$\tau \dot{\phi} = 1 \quad (5)$$

The basic idea behind these equations consists of building a stable dynamical system which is modulated by means of nonlinear subsystems  $f(\phi, r)$  to accomplish the desired behavior. On this purpose, instead of the time dimension, the system reacts based on the phase variable  $\phi$ , which is updated according to a periodic linear system (5) with  $\phi \in [0, 2\pi]$ ,  $\phi_0 = 0$ . This is also called *canonical system*.  $y$  is the periodic trajectory defined by the physiotherapist,  $g$  is its mean, and  $z$  is an auxiliary variable to create a second order system in state-space model. The parameters  $\alpha_z$ ,  $\beta_z$ ,  $\tau$ ,  $r$  define the dynamics of the system. By setting  $\alpha_z = 4\beta_z$  and  $\alpha_z, \beta_z > 0$  the stability is ensured,  $\tau$  is the time constant which must be set to the period divided by  $2\pi$ , and  $r$  is set to 1.

The functions  $f(\phi, r)$  are linear combinations of  $N$  Von Mises basis functions. They drive the system according to the phase  $\phi$  and can be learned to follow the desired trajectory:

$$f(\phi, r) = \frac{\sum_{i=1}^N w_i \psi_i(\phi)}{\sum_{i=1}^N \psi_i(\phi)} r \quad (6)$$

$$\psi_i(\phi) = \exp(h_i(\cos(\phi - c_i) - 1)) \quad (7)$$

In these equations,  $\psi_i(\phi)$  are the basis functions whose values are modulated by  $w_i$ . The centers of the basis functions  $c_i$  must be chosen properly to make good approximations, and  $h_i$  is related to the width of the shape. The values of  $w_i$  are estimated from the trajectories using regression (Atkeson et al., 1997; Fanger et al., 2016). An important decision is to establish a common canonical system for the three degrees of freedom (so they are synchronized by the same phase). However, each limb is encoded as a separate DMP to generate its own reference trajectory. The larger the value of  $N$ , the greater will be the precision of the resulting DMP.

Figures 2 shows the fitting of the basis functions and the original trajectories based on this parameter  $N$ , and Figure 3 shows the error in terms of their difference.

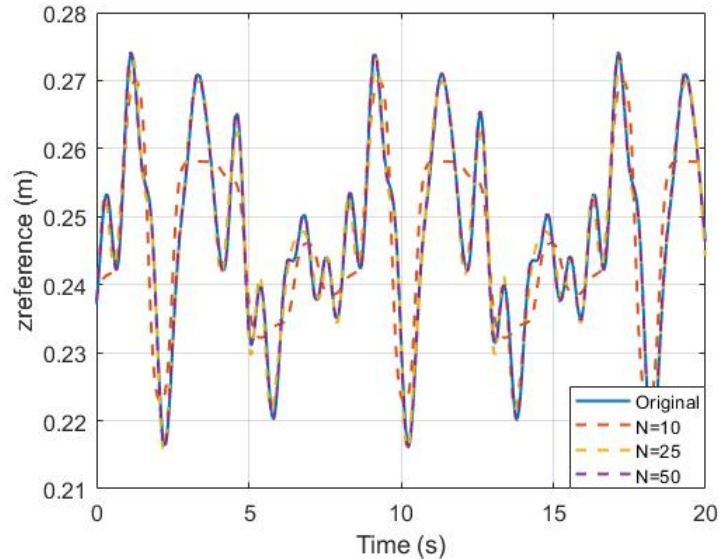

**Figure 2.** Original and generated reference trajectories in function of  $N$ .

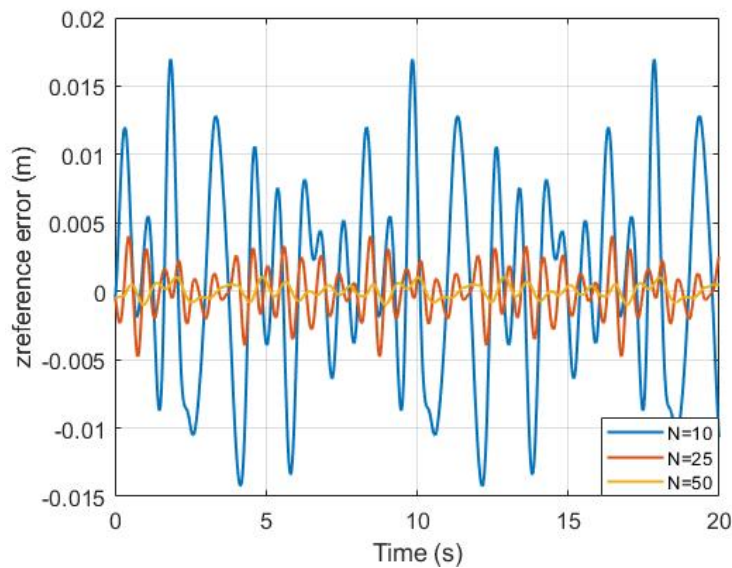
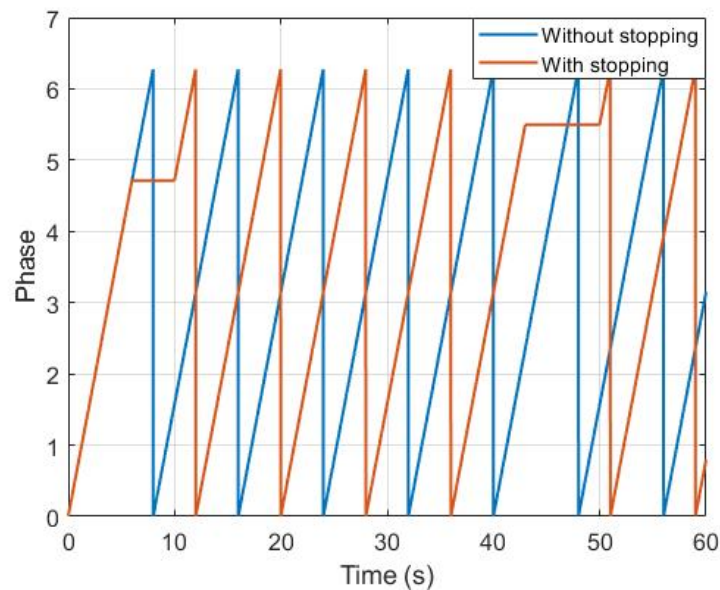

**Figure 3.** Error between both trajectories in function of  $N$ .

### 3.2. DMP Phase Stopping

The specialist can stop momentarily the robot's movement. This is useful if the physiotherapist detects an anomaly during the exercise (for example, because the patient is not performing it correctly), or the patient experiences pain, fatigue, nervousness, etc. Figure 4 shows the evolution of the phase. The blue line corresponds to the natural evolution if no obstacle is found. In red, the phase

is stopped twice: in  $t \in [6..10]$  s and  $t \in [43..50]$  s. This phase stopping will be reflected in the robot trajectory tracking described in Section 4.



**Figure 4.** Phase normal evolution (blue) and voluntarily stopped (red).

#### 4. Parallel Robot Task Space Controller

Robot control can be addressed by using two types of strategies: joint space control and task space control. The first one assumes direct action upon the motors of each joint. In this case, position, velocity and acceleration references are usually provided as time-dependent variables and the objective of the controller is to follow asymptotically the desired trajectory regardless of possible disturbances or non-modelled dynamics.

On the other hand, in task space control the desired position, velocity and acceleration are provided with respect to the end effector. In this work, a PD with gravity compensation in task space has been developed. The control action  $\tau_c$  is given by the expression:

$$\tau_c = J^T(q) \cdot K_p \cdot (x_d - x) - J^T(q) \cdot K_d \cdot \dot{q} + G(q) \quad (8)$$

where  $K_p$  and  $K_d$  are symmetric positive definite matrices,  $J$  is the Jacobian matrix of the robot manipulator,  $x$  and  $x_d$  are the actual and reference end effector positions, and  $q$  is the vector of joint coordinates.

If  $J$  is full-rank for all joint configurations  $q$ , then

$$\begin{aligned} x &= x_d \\ \dot{x}_d &= 0 \end{aligned} \quad (9)$$

is a globally asymptotically stable equilibrium point for the closed-loop system (2) and (8).

Figure 5 shows the control scheme implemented in this paper. The reference generation for the mobile platform of the robot is generated using the DMP technique presented in Section 3. The DMP block has an input (*Phase stopping*) which allows to freeze the phase  $\phi$ . While it is in low level, the signal evolves normally outputting the estimated reference  $x_d$  as the canonical system evolves, and when it turns high, the canonical system stops and the DMP keeps emitting the last value of  $x_d$  until the *Phase stopping* turns back low, after which the systems resumes the operation. The value of  $x_d$  contains the heave and orientation references since a task space controller is employed thereafter.

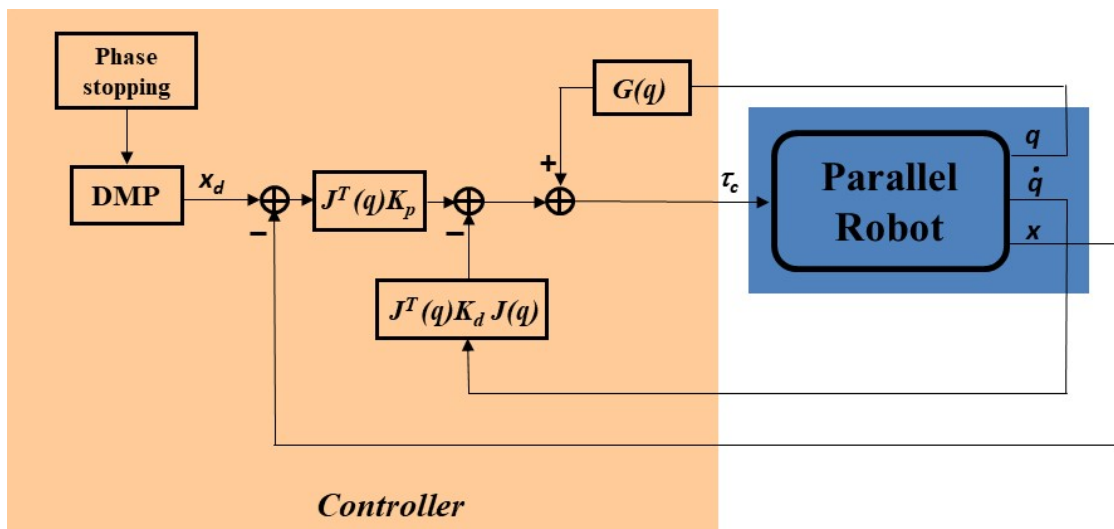

**Figure 5.** Control scheme based on task space controller and DMP.



Figure 6 shows the reference and actual position of the mobile platform's pitch angle, and Figure 7 plots the error, which demonstrates the precision of the controller. The values of the DMP parameters are  $\alpha_z = 48$  and  $\beta_z = 12$ . The task space controller has proportional gains 200000 for heave and 150000 for pitch and roll, and the derivative term is 1000.

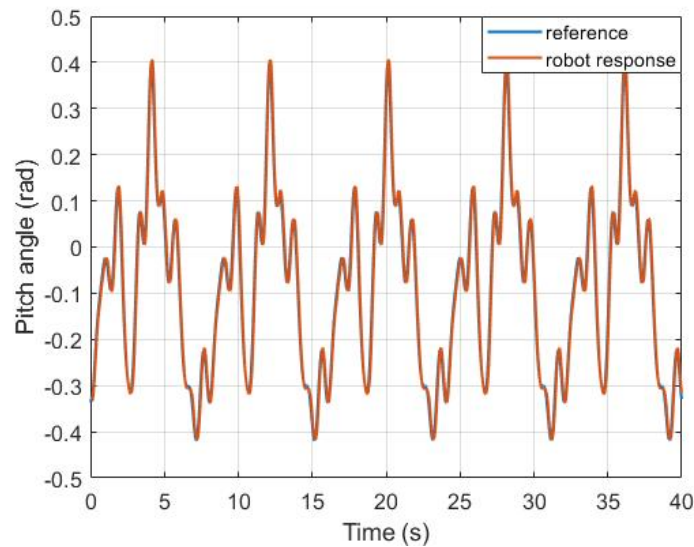

**Figure 6.** Reference and actual pitch angle position using DMP-based task space controller.

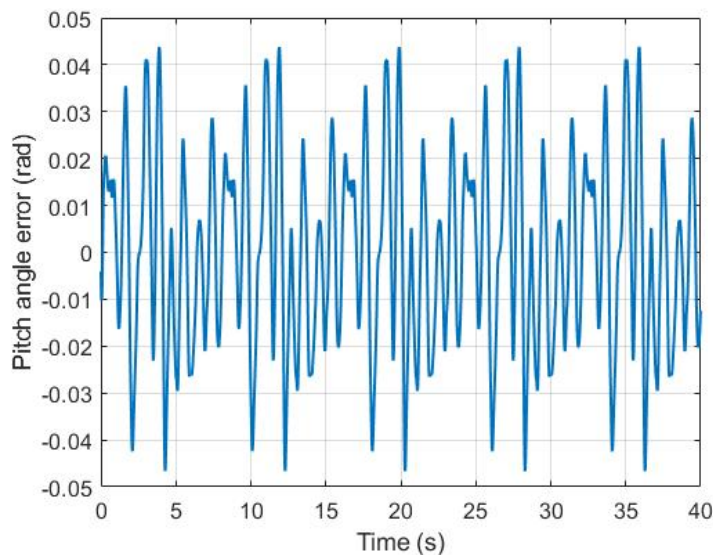

**Figure 7.** Measured pitch angle error using DMP-based task space controller.

## 5. Lower limb Rehabilitation Exercises

Figure 8 shows four of the possible movements of the ankle: plantar/dorsiflexion, inversion and eversion. The most common injuries are ankle sprains, representing 38% of locomotor system injuries. Sudden movements in the eversion direction cause these sprains by stretching and tearing the ligaments (Safran et al., 1999).

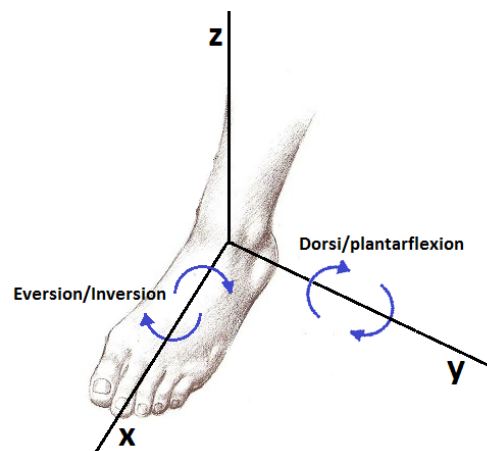

**Figure 8.** Ankle movements: plantar/dorsiflexion, and inversion/eversion.

In many cases rehabilitation is not performed, so sprains are not treated. This fact leads to a likely chronic injury between 80% and 90% of times and causes ligament instability in absence of rehabilitation, which keeps increasing over time as new injuries occur. In order to avoid this, proper rehabilitation exercises are indispensable.

There are different exercises that can be performed to treat or strengthen injured ankles, and the parallel robot presented in Section 2 is intended to help in this context. The exercises can be either passive or active. Passive exercises are those in which the patient does not make any voluntary movement and so the robot dictates the full trajectory based on its program (Abu-Dakka et al., 2015), while active exercises imply certain voluntary movements performed by the patient, thus increasing the interaction between human and robot.

Figure 9 shows the rehabilitation robot. As mentioned in Section 2, it has three kinematic limbs that control the mobile platform (roll/pitch orientations and heave translation). The human lower limb is tied to an orthopedic boot that is attached to the mobile platform by means of an ATI Delta

SI-330-30 force/torque sensor. Thanks to this, the specialist can set the required movements to make in order to reproduce a trajectory or rehabilitation exercise.

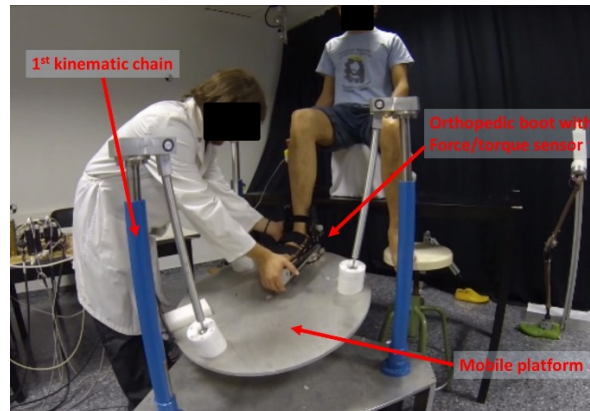
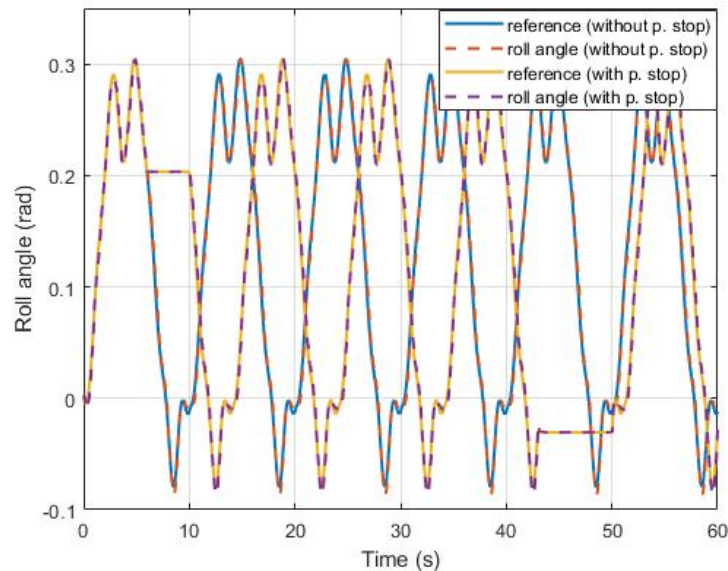

**Figure 9.** Rehabilitation robot and exercise preparation.

Once these movements are stored in the control unit of the robot, they are encoded using the procedure shown in Section 3.1. The DMP trajectory adaptation is used as reference ( $x_d$ ) for the task space controller.

The rehabilitation robot incorporates different safety devices. Firstly, the forces and torques applied to the ankle are monitored during the exercise. Moreover, an emergency stop button allows to stop the robot motion and remove the power if an emergency occurs. Finally, there is an additional button that stops the phase variable when necessary, until new command is sent to continue the exercise.

Figure 10 shows the results of a plantar/dorsiflexion passive ankle rehabilitation exercise. The robot is programmed to follow a specific position reference defined by a specialist, which consists of a sinusoidal-based signal for the roll angle. The blue signal is the original reference (without any phase stopping), and the black one is the response of the robot for that situation. Conversely, the cyan and red signals represent, respectively, the same variables when performing a phase stopping in  $t \in [6..10]$  s and  $t \in [43..50]$  s. In such intervals, the reference does not change. Both experiments perform a very accurate tracking.



**Figure 10.** Rehabilitation exercise with and without phase stopping.

## 6. Conclusions

In this paper, a learning algorithm based on Dynamic Movement Primitives has been proposed for trajectory adaptation of a Parallel Robot in ankle rehabilitation tasks. This algorithm adjusts the exercises by making the system subject to a manipulable phase variable that intervenes in the reference signal generation, which is integrated in the control scheme.

The position control has been designed in task space, which allows to handle cartesian coordinates directly by means of the Jacobian matrix. This is possible due to the direct and inverse kinematic models that had been solved in previous work.

Therefore, the adaptation mechanism lies in the fact that the robot can be provided with external feedback by altering the normal course of the DMP phase variable. This feedback is received by using a device, such as a button, which causes the phase variable to stop. When it occurs, the robot keeps controlling the position, although the reference does not move forward. This is a convenient way to prevent undesired movements from happening on the patient.

Under this premise, passive exercises have been performed for one of the degrees of freedom. The experiment shows that the reference generation was successful, and the algorithm could accurately follow this reference while being able to stop the exercise.

In future developments, improvements to this algorithm can be designed for more complex ankle rehabilitation exercises (for example, by using more degrees of freedom) and an automatic adaptation of the phase signal can be performed, increasing the flexibility of the system. Furthermore, the applied forces can be sent to the controller thanks to the force sensor, improving the control performance. Finally, as the patient performs the same exercise several times, such exercise can be intelligently modified in order to adapt to the hopefully improved condition of their ankle.

### Acknowledgements

This work has been partially funded by FEDER-CICYT project with reference DPI2017-84201-R financed by Ministerio de Economía, Industria e Innovación (Spain).

### References

- Abu-Dakka, F. J., Valera, A., Escalera, J. A., Vallés, M., Mata, V., & Abderrahim, M. (2015). Trajectory adaptation and learning for ankle rehabilitation using a 3-PRS parallel robot. *Lecture Notes in Computer Science (Including Subseries Lecture Notes in Artificial Intelligence and Lecture Notes in Bioinformatics)*, 9245, 483–494. [https://doi.org/10.1007/978-3-319-22876-1\\_41](https://doi.org/10.1007/978-3-319-22876-1_41)
- Atkeson, C. G., Moore, A. W., & Schaal, S. (1997). Locally Weighted Learning. *Artificial Intelligence Review*, 11(1–5), 11–73. [https://doi.org/10.1007/978-94-017-2053-3\\_2](https://doi.org/10.1007/978-94-017-2053-3_2)
- Brockett, C. L., & Chapman, G. J. (2016). Biomechanics of the ankle. *Orthopaedics and Trauma*, 30(3), 232–238. <https://doi.org/10.1016/j.mporth.2016.04.015>
- Dai, J. S., Zhao, T., & Nester, C. (2004). Sprained Ankle Physiotherapy Based Mechanism Synthesis and Stiffness Analysis of a Robotic Rehabilitation Device. *Autonomous Robots*, 16(2), 207–218. <https://doi.org/10.1023/B:AURO.0000016866.80026.d7>
- Díaz-Rodríguez, M., Mata, V., Valera, Á., & Page, Á. (2010). A methodology for dynamic parameters identification of 3-DOF parallel robots in terms of relevant parameters. *Mechanism and Machine Theory*, 45(9), 1337–1356. <https://doi.org/10.1016/j.mechmachtheory.2010.04.007>
- Díaz, I., Gil, J. J., & Sánchez, E. (2011). Lower-Limb Robotic Rehabilitation: Literature Review and Challenges. *Journal of Robotics*, 2011(i), 1–11. <https://doi.org/10.1155/2011/759764>
- Fanger, Y., Umlauft, J., & Hirche, S. (2016). Gaussian Processes for Dynamic Movement Primitives with application in knowledge-based cooperation. *IEEE International Conference on Intelligent Robots and Systems, 2016-Novem*, 3913–3919. <https://doi.org/10.1109/IROS.2016.7759576>
- Gosselin, C., & Angeles, J. (1990). Singularity Analysis of Closed-Loop Kinematic Chains. *IEEE Transactions on*



- Robotics and Automation*, 6(3), 281–290. <https://doi.org/10.1109/70.56660>
- Hesse, S., & Uhlenbrock, D. (2000). A mechanized gait trainer for restoration of gait. *Journal of Rehabilitation Research and Development*, 37(6), 701–708.
- Ijspeert, A. J., Nakanishi, J., Hoffmann, H., Pastor, P., & Schaal, S. (2013). Dynamical movement primitives: Learning attractor models for motor behaviors. *Neural Computation*, 25(2), 328–373. [https://doi.org/10.1162/NECO\\_a\\_00393](https://doi.org/10.1162/NECO_a_00393)
- Ijspeert, A. J., Nakanishi, J., & Schaal, S. (2002). Movement imitation with nonlinear dynamical systems in humanoid robots. *Proceedings - IEEE International Conference on Robotics and Automation*, 2, 1398–1403. <https://doi.org/10.1109/robot.2002.1014739>
- Liu, G., Gao, J., Yue, H., Zhang, X., & Lu, G. (2006). Design and kinematics simulation of parallel robots for ankle rehabilitation. *2006 IEEE International Conference on Mechatronics and Automation, ICMA 2006, 2006*, 1109–1113. <https://doi.org/10.1109/ICMA.2006.257780>
- Nakanishi, J., Morimoto, J., Endo, G., Cheng, G., Schaal, S., & Kawato, M. (2004). Learning from demonstration and adaptation of biped locomotion. *Robotics and Autonomous Systems*, 47(2–3), 79–91. <https://doi.org/10.1016/j.robot.2004.03.003>
- Nemec, B., & Ude, A. (2012). Action sequencing using dynamic movement primitives. *Robotica*, 30(5), 837–846. <https://doi.org/10.1017/S0263574711001056>
- Patel, Y. D., & George, P. M. (2012). Parallel Manipulators Applications—A Survey. *Modern Mechanical Engineering*, 02(03), 57–64. <https://doi.org/10.4236/mme.2012.23008>
- Paul, R. P. (1981). *Robot Manipulators: Mathematics, Programming, and Control: the Computer Control of Robot Manipulators* (p. 279).
- Reinkensmeyer, D. J., Aoyagi, D., Emken, J. L., Galvez, J. A., Ichinose, W., Kerdanyan, G., Maneekobkunwong, S., Minakata, K., Nessler, J. A., Weber, R., Roy, R. R., De Leon, R., Bobrow, J. E., Harkema, S. J., & Reggie Edgerton, V. (2006). Tools for understanding and optimizing robotic gait training. *Journal of Rehabilitation Research and Development*, 43(5), 657–670. <https://doi.org/10.1682/JRRD.2005.04.0073>
- Safran, M. R., Benedetti, R. S., Bartolozzi, A. R., & Mandelbaum, B. R. (1999). Lateral ankle sprains: A comprehensive review part 1: Etiology, pathoanatomy, histopathogenesis, and diagnosis. In *Medicine and Science in Sports and Exercise* (Vol. 31, Issue 7 SUPPL., pp. S429–S437). <https://doi.org/10.1097/00005768-199907001-00004>
- Saglia, J. A., Tsagarakis, N. G., Dai, J. S., & Caldwell, D. G. (2013). Control strategies for patient-assisted training using the ankle rehabilitation robot (ARBOT). *IEEE/ASME Transactions on Mechatronics*, 18(6), 1799–1808. <https://doi.org/10.1109/TMECH.2012.2214228>
- Schaal, S. (2006). Dynamic Movement Primitives -A Framework for Motor Control in Humans and Humanoid Robotics. In *Adaptive Motion of Animals and Machines* (pp. 261–280). [https://doi.org/10.1007/4-431-31381-8\\_23](https://doi.org/10.1007/4-431-31381-8_23)
- Sui, P., Yao, L., Lin, Z., Yan, H., & Dai, J. S. (2009). Analysis and synthesis of ankle motion and rehabilitation robots. *2009 IEEE International Conference on Robotics and Biomimetics, ROBIO 2009*, 3, 2533–2538. <https://doi.org/10.1109/ROBIO.2009.5420487>
- Tsoi, Y. H., Xie, S. Q., & Graham, A. E. (2009). Design, modeling and control of an ankle rehabilitation robot. *Studies in Computational Intelligence*, 177, 377–399. [https://doi.org/10.1007/978-3-540-89933-4\\_18](https://doi.org/10.1007/978-3-540-89933-4_18)



- Vallés, M., Díaz-Rodríguez, M., Valera, Á., Mata, V., & Page, Á. (2012). Mechatronic development and dynamic control of a 3-dof parallel manipulator. *Mechanics Based Design of Structures and Machines*, 40(4), 434–452. <https://doi.org/10.1080/15397734.2012.687292>
- Xie, S. (2016). Advanced robotics for medical rehabilitation: current state of the art and recent advances. In *Springer tracts in advanced robotics* (Issue 108).
- Yoon, J., Ryu, J., & Lim, K. B. (2006). Reconfigurable ankle rehabilitation robot for various exercises. *Journal of Robotic Systems*, 22(SUPPL.), 15–33. <https://doi.org/10.1002/rob.20150>

