

Performance Improvement of a Feedback Control System Using an Accelerometer-Enhanced Velocity Observer

Yu-Sheng Lu*, Chung-Heng Lee

Department of Mechatronic Engineering, National Taiwan Normal University, Taipei 106, Taiwan.

Received 22 February 2016; received in revised form 19 March 2016; accepted 16 April 2016

Abstract

The paper shows how an accelerometer-enhanced velocity estimator can be used to improve the tracking performance of a feedback control system. In contrast to conventional velocity estimators that use positional information only, the accelerometer-enhanced velocity estimator fuses the position sensor and the accelerometer together to produce an improved velocity estimation. Experimental results are presented to show the effectiveness of the accelerometer-enhanced velocity estimator on improving the tracking performance of a linear motion stage.

Keywords: Accelerometer, feedback control system, linear motion stage, velocity estimator, velocity observer

1. Introduction

A linear motion stage, shown in Fig. 1, is the experimental system, whose schematic is shown in Fig. 2. In the experimental system, a permanent-magnet synchronous ac motor is driven by a regulator current converter that receives a torque-producing command in the form of analog voltage from the DAC interface of a controller core. The controller core is a DSP/FPGA-based system with DIO, ADC and DAC interfaces. The FPGA is configured to interface with an optical linear encoder for position counting and velocity detection. Here, the velocity detection implemented in the FPGA is based on the so-called inverse-time method (ITM) [1] that estimates velocity by measuring the time elapsed during two consecutive rising edges of a quadrature encoder signal. Moreover, the ADC interface in the FPGA acquires acceleration from an accelerometer.

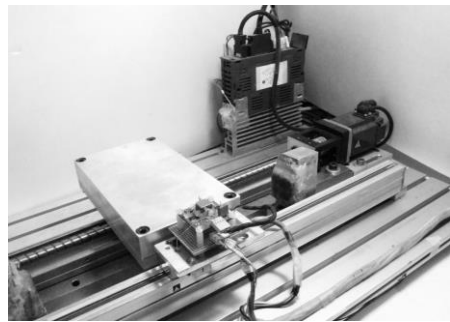

Fig. 1 Photo of the experimental system

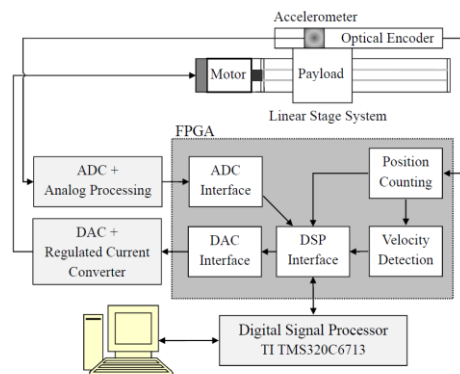

Fig. 2 Schematic of the experimental system

The DSP reads feedback information on the acceleration, position and velocity (when the ITM is used) through the DSP interface in the FPGA, calculates velocity estimation and control algorithms, and sends the control effort to the regulator current converter through the DAC interface. The output shaft of the motor is connected to a ball screw that translates rotational motion of the rotor to linear motion of the payload, on which the accelerometer is mounted. In this paper, the position control of the payload is considered.

* Corresponding author. Email: luyss@ntnu.edu.tw

2. Method

The linear motion stage is used to evaluate the performance of two velocity observers: one is an accelerometer-enhanced velocity estimator, the DCVO [2], and the other is the conventional, popular estimator using the inverse-time method (ITM). The plant is modeled as a second-order system described by

$$\ddot{x} + a_2\dot{x} + a_1x = b(u + d) \quad (1)$$

in which $a_2 = 4.857$, $a_1 = 0$, $b = 11432$, x and u denote the plant's output and input, respectively, and d denotes an uncertain input disturbance. The feedback controller is designed based on the Integral Variable- Structure Control (IVSC) law [3]. Define a switching function

$$s = \dot{e} + c_0e + c_1z \quad (2)$$

where $c_0 = 2\omega_n$, $c_1 = \omega_n^2$, and $z = \int_0^t edt + z_0$.

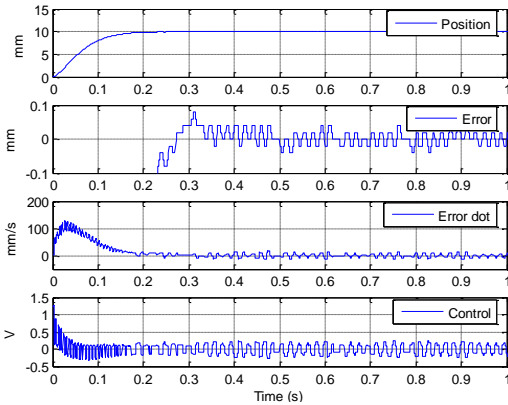

Fig. 3 Step response with the ITM

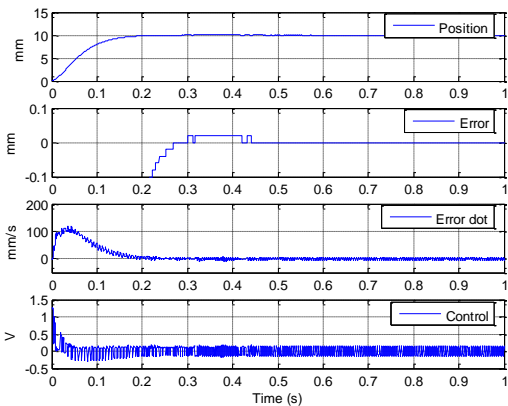

Fig. 4 Step response with the DCVO

Here, $z_0 = -c_1^{-1}(\dot{e}_0 + c_0e_0)$ and $\omega_n = 30$. Let the IVSC law be

$$u = \hat{\alpha}\dot{x} - \hat{\beta}(-\ddot{r} + c_0\dot{e} + c_1e + c_2s) - \{\Delta\alpha|\dot{x}| + D + \Delta\beta|-\ddot{r} + c_0\dot{e} + c_1e|\} \text{sgn}(s) \quad (3)$$

in which $c_2 = \omega_n$, $\hat{\beta} = b^{-1}$, $\Delta\beta = 0.4\hat{\beta}$, $\hat{\alpha} = b^{-1}a_2$, $\Delta\alpha = 0$, and $D = 0.1$.

3. Results and Discussion

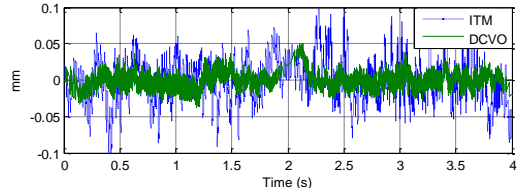
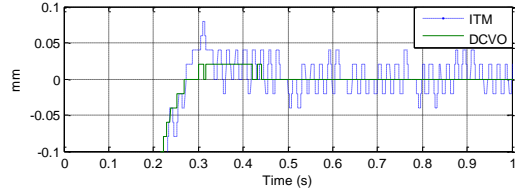

Fig. 5 Output error with a resolution of 20 μm

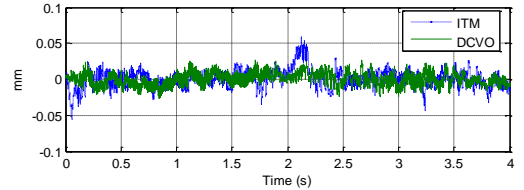
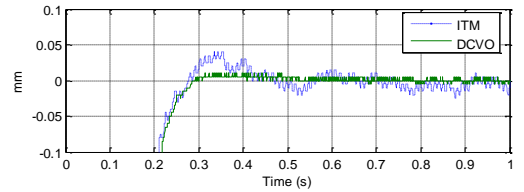

Fig. 6 Output error with a resolution of 5 μm

Two references are used in the following experiments: one is a step reference of 10 mm, and the other is a sinusoidal reference of 0.25 Hz. Figs. 3 and 4 show the step responses with the ITM and the DCVO, respectively. It is seen that the switching frequency of the control input associated with the DCVO is much faster than with the ITM, meaning that the DCVO enables faster correction of output errors than the ITM. The upper subplot of Fig. 5 shows the error responses to the step reference, whereas the lower subplot shows the error responses to the sinusoidal reference. It is seen that compared with the ITM, the

DCVO reduces the output error with the aid of an accelerometer. Moreover, in the case of regulation control, output precision is limited by the sensor resolution. In the subsequent experiments, the resolution of the positional sensor is reduced to 5 μm . Likewise; the upper subplot of Fig. 6 shows the error responses to the step reference, whereas the lower subplot shows the error responses to the sinusoidal reference. It can be clearly seen that the DCVO outperforms the ITM. Because of the advance of MEMS technology, accelerometers become cheap and ubiquitous, making the accelerometer-enhanced velocity estimator a cost-effective scheme with improved performance.

4. Conclusions

In this paper, two velocity estimation schemes have been experimentally evaluated using the same IVSC law. The experimental results show that the DCVO enables higher-speed error correction and leads to better tracking precision than the conventional estimator using the ITM.

Acknowledgement

The authors would like to thank the Ministry of Science and Technology for their support of this research under Grants No. MOST 104-2221-E-003-011-MY2.

References

- [1] J. S. Farrokh, H. Vincent, and C. S. J. Chen, "Discrete-time adaptive windowing for velocity estimation," *IEEE Trans. Contr. Syst. Technol.*, vol. 8, no. 6, pp. 1003-1009, 2000.
- [2] Y. S. Lu and S. H. Liu, "The design and implementation of an accelerometer-assisted velocity observer," *ISA Transactions*, vol. 59, pp. 418-423, Nov. 2015.
- [3] J. H. Lee, "Highly robust position control of BLDDSM using an improved integral variable structure system," *Automatica*, vol. 42, pp. 929-935, 2006.