

# POWER SYSTEM STABILIZER DESIGN USING NOTCH-FILTER – BARKA II (OMAN) - CASE STUDY

H.M. Soliman, M.H. Albadi\*, A.Al-Maamari, and A.Al-Kasbi

Department of Electrical and Computer Engineering, Sultan Qaboos University, Muscat 123, PO Box 33, Oman

**ABSTRACT:** The use of power system stabilizers (PSSs) to damp power system swing mode oscillations is of extreme practical importance. This manuscript presents an approach to the stabilization of a single machine infinite bus system (SMIB). The proposed control is based on the notch-filter approach to cancel the poles near to the imaginary axes. The approach is based on the root locus method. Application to Barka II power station connected to the main interconnected system of Oman is presented. The peak load at summer is considered as the system is near to instability. The Barka SMIB is modeled as a fourth order non-linear system. A linearized model is then obtained using MATLAB/Simulink. The simulation results validate the proposed design for the PSS.

**Keywords:** Notch-filter; Power system stabilizers; Root locus.

## تصميم مثبت نظام الطاقة باستخدام مرشح الشق - دراسة حالة بركاء II (عمان)

هـ.م. سليمان ، م.ح. البادي\* ، أ. المعمرى ، أ. الكاسبي

**المخلص:** يعد استخدام مثبتات نظام ال قدرة لتقليل تأرجح نظام القدره عملية نو أهمية كبرى. وتقوم هذه الورقة البحثية بتقديم طريقة لتحقيق الثبات في نظام قدرة (مولد واحد متصل بشبكة كبيره). ويستند عنصر التحكم المقترح إلى نهج مرشح الشق لإلغاء الجذور القريبة من المحور الرأسي (التخيلي). ويعتمد النهج على طريقة المحل الهندسي للجزور. وتم التطبيق على محطة كهرباء بركاء II المتصلة بالشبكة الرئيسييه في سلطنة عمان. و يعتبر الحمل الاعلى في الصيف بمثابة اقتراب النظام من عدم الاستقرار. وتم تصميم مثبت نظام القدرة لمحطة توليد بركة عند اتصالها بشبكة عمان على أنه نظام غير خطي من الدرجة الرابعة. ثم تم استنتاج نموذج خطي باستخدام MATLAB / Simulink. و اثبتت نتائج المحاكاة صحة التصميم المقترح لمثبت نظام الطاقة.

**الكلمات المفتاحية:** مرشح حزمه ضيقه للتردد؛ مثبتات نظم القدرة؛ المحل الهندسي للجزور.

\*Corresponding author's e-mail: mbadi@squ.edu.om



## NOMENCLATURE

CPSS	Conventional PSS
FACTS	Flexible ac transmission system
MIS	Main Interconnected System
PSS	Power System Stabilizer
PID	Proportional–Integral–Derivative
SMIB	Single Machine Infinite Bus system
$P_m$	Mechanical input power of the generator in p.u.
$P_e$	Electrical output power of the generator in p.u.
$x'_d$	Generator direct-axis transient reactance in p.u.
$x_d, x_q$	Direct and quadrature-axis synchronous reactances, respectively, in p.u.
$x_e$	Transmission line and transformer reactance in p.u.
$T'_{do}$	d-axis open circuit field time constant, sec.
$M$	Inertia constant in seconds.
$\delta$	Rotor angle in rad.
$\omega$	Rotor speed in rad/s.
$E'_q$	Quadrature-axis transient voltage in p.u.
$E_f$	Field voltage in p.u.
$K_E, T_E$	Exciter-AVR gain and time constant, respectively.
$V$	Infinite bus voltage in p.u.
$P, Q$	Machine real and reactive power loading at the infinite bus in p.u, respectively.
$S$	Laplace operator.

## 1. INTRODUCTION

Power systems are frequently subjected to undesirable disturbances due to several reasons such as continuous load variations, set-point changes, lightning strikes, and faults. Consequently, they exhibit low frequency oscillations that may either decay gradually, or continues to grow, causing system separation. These low frequency oscillations are due to the lack of electromechanical system damping (Kundur, Balu *et al.* 1994, Sauer and Pai 1998, Pal and Chaudhuri 2006, Machowski, Bialek *et al.* 2008). The desired additional damping can be provided by a supplementary excitation control through a power system stabilizer (PSS). The main problem encountered in conventional PSS design is that power systems constantly experience changes in operating conditions due to variations in generation and load. Therefore, a conventionally designed PSS may fail to maintain stability over a wide range of operating points. Further, the performance of conventional PSS is degraded once the deviation from the nominal point becomes significant. Coping with uncertainties imposed by continuous variation in operating points, has become the priority of the PSS designers. To make the performance of a PSS robust, the design algorithm must take into consideration power system uncertainty due to load variation. Power system uncertainty can be modeled in different approximations: interval plant (Soliman, Elshafei *et al.* 2000; Soliman 2014), polytopic form (Rao and Sen

2000), norm-bounded form (Soliman and Shafiq 2015),  $\mu$ -synthesis (Castellanos, Messina *et al.* 2008), and linear fractional transformation (Werner, Korba *et al.* 2003).

There exist different PSS designs. The PSS that keeps system stability in the face of system uncertainty is termed robust stabilizer; whereas if it can retain the closed loop poles in a desired region so as to achieve good dynamic performance, it is called pole placer. The design can be carried out in the s-domain, complex frequency, or in the time domain. In the s-domain, a phase-lead or PID-robust PSS using Kharitonov theorem is presented in Soliman, Elshafei *et al.* (2000) and Soliman (2014), respectively. In the time domain, the powerful linear matrix inequality (LMI) optimization is used for the synthesis of pole placer PSS (Rao and Sen 2000). Power systems that are subjected to a series of lightning strikes with the associated auto reclosure of circuit breakers are represented as a Markov chain and the pole placer synthesis is presented in Soliman and Shafiq (2015). When a power system is equipped with a FACTS controller in addition to the PSS, using both controllers provides tighter control grip on the system. In case of failure of either one, a design called reliable control is presented in Soliman, Dabroum *et al.* (2011) to preserve system stability.

Fuzzy logic has recently emerged as a potential technique for PSS design. Besides its ability to accommodate the heuristic knowledge of a human expert, the advantage of a fuzzy PSS is that it represents a nonlinear mapping that can cope with the nonlinear nature of power systems. An adaptive PSS that uses on-line self-learning fuzzy systems is discussed in Elshafei, El-Metwally *et al.* (2005). Although the performance of a well-designed model-free fuzzy PSS is acceptable, it lacks systematic stability analysis and controller synthesis. Many attempts to overcome this drawback have been made by providing a model-based fuzzy PSS that guarantees stability and performance of power systems. In the past ten years, research efforts on fuzzy logic control have been devoted to model-based fuzzy control systems (Feng 2006). Stability and performance limits of model-based fuzzy control systems can be achieved via LMI techniques (Tanaka and Wang 2004). An indirect adaptive fuzzy controller as a power system stabilizer also, used to damp inter-area modes of oscillation is presented in Hussein, Saad *et al.* (2010).

Most power system controls are subject to saturation due to physical limitations of actuators (Kundur, Balu *et al.* 1994; Sauer and Pai 1998). None of the above references tackled the problem of control signal limits practically imposed. When the controller saturation is not considered in the design phase, the performance of the designed control system seriously deteriorates. The design of a robust PSS pole placer taking into consideration the control constraints is reported recently in Soliman and Shafiq (2015) and Soliman and El Metwally (2017). The designs achieve regional pole placement, to obtain good dynamic behavior against load variation; subject to the control limit constraint. Metaheuristics in the

design of robust PSS is given by Peres, Júnior *et al.* (2018). Metaheuristics are also used to tackle power system nonlinearities as presented in Rahmatian and Seyedtabaai (2019).

Although the above progress in PSS design tackles difficult problems of power systems dynamics, it uses state or output feedback which is not the standard form of the conventional PSS (CPSS). In this paper, three PSS designs are presented: 2 conventional (single lead, double lead) and the new proposed approach (Notch-filter based double lead). The paper demonstrates that the conventional approaches fail to stabilize the system whereas the newly proposed Notch-filter based double lead provides a very effective method to stabilize the system. This result is due to the fact that the system has slightly damped complex poles. In addition, the paper uses a Notch-filter based PSS to stabilize a practical power system in Oman (Barka II Power Plant).

The paper is organized as follows. The mathematical model of SMIB power system and the problem statement are presented in Section 2. Section 3 presents the problem solution using the root locus method and the stability analysis of the closed-loop system under the proposed control scheme. Simulation results for the SMIB power system are provided in Section 4 to validate the effectiveness of the proposed controller. The paper is concluded in Section 5.

## 2. SINGLE-MACHINE INFINITE-BUS MODEL

In this section, the mathematical model for the non-linear dynamics of a single-machine infinite-bus system (SMIB) is presented. The SMIB will be used in the design procedure, which will be addressed in the next section. The machine delivers the electrical power to the infinite bus. The voltage regulator controls the input to a solid-state rectifier excitation system, which provides the field voltage to maintain the generator terminal voltage at a desired value, Fig. 1 (Kundur, Balu *et al.* 1994, Sauer and Pai 1998).

The states of the machine are its rotor angle  $\delta$ , its speed  $\omega$ , its quadrature-axis transient voltage  $E'_q$ , and the field voltage  $E_f$ . The exciter-voltage regulator

is modeled as a first order transfer function. All of the variables are normalized on a per-unit (p.u.) basis, except the time constant is in seconds. The mathematical nonlinear model describing the dynamics of SMIB is given by the following equation The states of the machine are its rotor angle, its speed, its quadrature-axis transient voltage, and the field voltage. The exciter-voltage regulator is modeled as a first order transfer function. All of the variables are normalized on a per-unit (p.u.) basis, except the time constant is in seconds. The mathematical nonlinear model describing the dynamics of SMIB is given by the following equation (Kundur, Balu *et al.* 1994; Sauer and Pai 1998):

$$\dot{\delta} = \omega - \omega_0 = \Delta\omega \quad (1)$$

$$\frac{2H}{\omega_0} \Delta\dot{\omega} = P_m - P_e = P_m - [E'_q + (x_q - x'_d)I_d]I_q \quad (2)$$

$$T_{d0}' \dot{E}'_q = E_f - [E'_q + (x_d - x'_d)I_d] \quad (3)$$

$$T_E \dot{E}_f = -E_f + K_E (V_{ref} - V_t + u) \quad (4)$$

where  $I_d$ ,  $I_q$ , and  $V_t$  are given by the following equation:

$$I_d = \frac{E'_q - V \cos \delta}{x'_d + x_e} \quad (5)$$

$$I_q = \frac{V \sin \delta}{(x_q + x_e)} \quad (6)$$

$$V_t = \sqrt{(I_q x_q)^2 + (E'_q - I_d x'_d)^2} \quad (7)$$

The power system model is linearized at a particular equilibrium point to obtain the linearized system model given in the state-space form.

$$\dot{x} = Ax + Bu \text{ \& } y = Cx \quad (8)$$

The components of the state vector are defined as  $x = [\Delta\delta, \Delta\omega, \Delta E'_q, \Delta E_f]^T$  where  $\Delta$  denotes the perturbation of the states, input, and outputs from their equilibrium values.

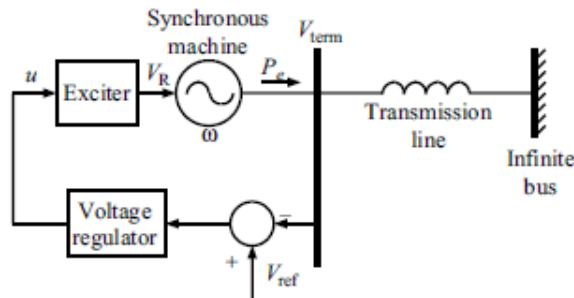

Figure 1. Single-machine infinite-bus system.

### 3. DESIGN OF PSS

In this section, three PSS designs will be presented: single lead, double lead and Notch-filter based double lead. It will be shown that the conventional single and double lead fail to stabilize the system. Whereas the Notch-filter based double lead provides a very effective method to stabilize the system. This is due to the fact that the system has slightly damped complex poles.

#### 3.1 Open Loop Response:

The system response without PSS for a cleared three phase fault at the generator terminal causing  $\Delta\delta=0.1$  rad is shown in Fig. 2.

It is evident that the open loop response is very oscillatory. So, a PSS is needed to damp the oscillations.

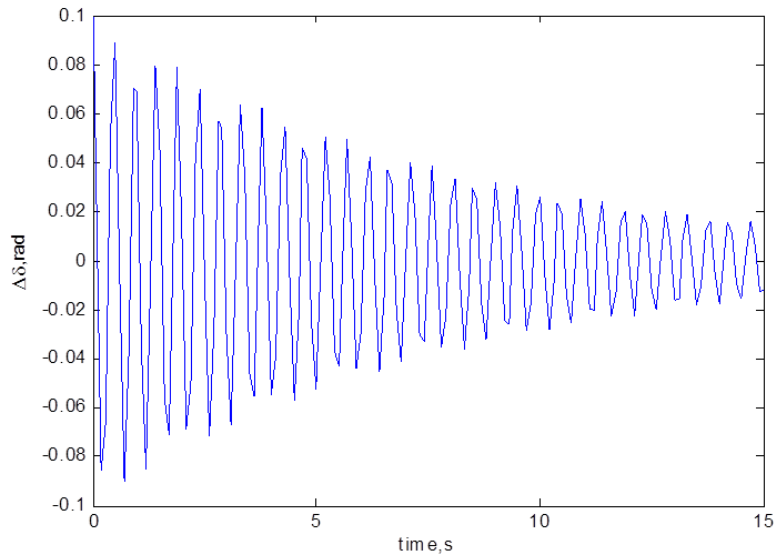

Figure 2. System response without power system stabilizer.

#### 3.2 PSS Design

The conventional PSS (CPSS) is a lead controller. It has two forms: single lead, or double lead; which have the forms:  $K(T_1s + 1)/(T_2s + 1)$ ,  $K(T_1s + 1)^2/(T_2s + 1)^2$ , respectively. Design trials using the root locus method will be presented.

##### 1) Design trial#1: Single and Double Lead PSS

The linearized model for Barka II working during the extreme summer condition is obtained from (11). Selecting typical values for the poles and zeros of a single lead controller, the PSS is given as follows:

The zoomed root locus for the single lead PSS is shown in Fig. 3. The zoomed root locus for the double lead PSS is shown in Fig. 4.

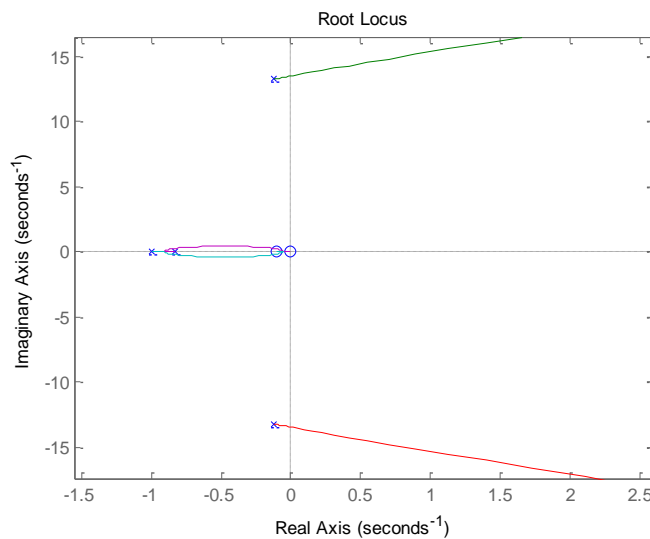

Figure 3. Zoomed root locus design for single lead power system stabilizer.

The PSS designed by the root locus method was unsuccessful because it contains pairs of complex-conjugate poles ( $-0.124 \pm j13.2$ ) that lie close to the imaginary axis in the s-plane as shown in Fig. 3 and Fig. 4. These poles are lightly damped. This will result in an unstable system even for small controller gain. To solve this problem, a notch filter is used to cancel those poles (pole-zero cancellation).

2) *Design trial#2: Notch-filter Based Double Lead PSS*

There are many transfer functions of a controlled process that contains pairs of complex-conjugate poles located close to the imaginary axis in the s-plane. This will result in a lightly damped performance.

One way to control this system is to design a controller with zeros near the undesirable lightly-damped poles of the plant. These zeros can attenuate the effect of the lightly-damped poles. The dominant closed-loop poles of the system can then

be placed in a more desirable position. Such a controller is called a notch filter. Before getting into the specifics of a notch filter, it should be noted that due to the nature of most systems, exact pole/zero cancellation cannot be obtained; nor should it be attempted. Approximate cancellation will give us many of the desirable characteristics without the pitfalls.

Unfortunately, this method is unreliable because when an added zero does not exactly cancel the corresponding unstable pole (which is always the case in real life), a part of the root locus will be trapped in the right-half plane. This causes the closed-loop response to be unstable. Therefore, the pole-zero cancellation method can be carried only in LHS of the complex plane (stable region).

Pole-zero cancellation is a straightforward search through the poles and zeros looking for matches that are within tolerance. The transfer functions are first converted to zero-pole-gain form. The notch filter is used to cancel complex-conjugate poles as seen in Fig. 5.

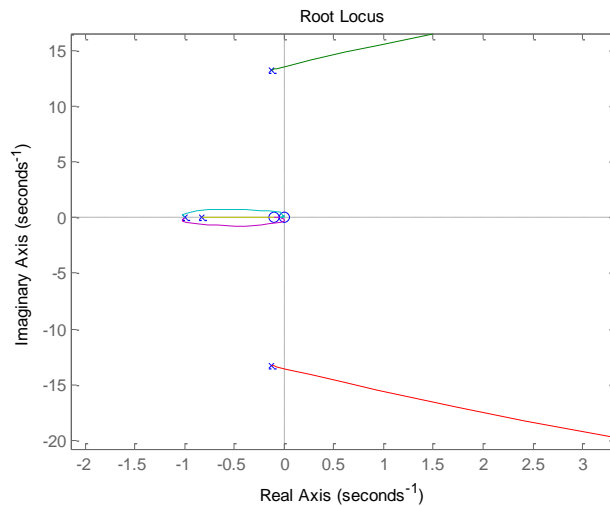

Figure 4. Zoomed root locus design for double lead power system stabilizer.

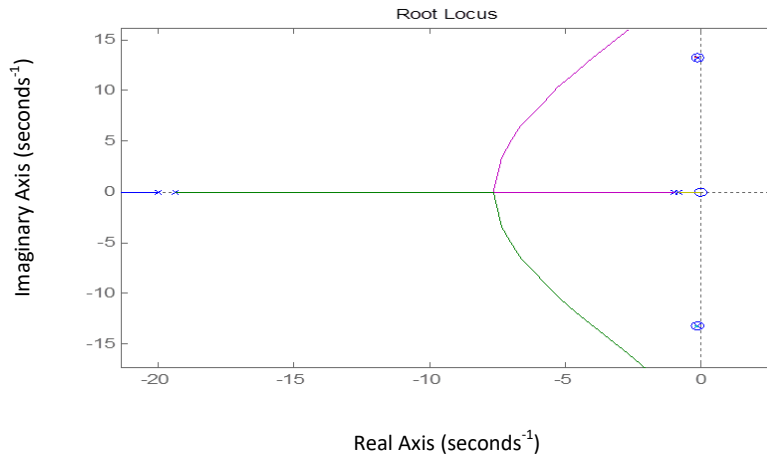

Figure 5. Root locus design for Notch-filter based double lead power system stabilizer.

To cancel those poles, we elapse on them complex-conjugate zeros. This method is known as pole-zero cancellation. As seen, the roots of the numerator of the controller are the same as the complex poles of the denominator of the plant; two poles at -1, -20 are selected for the denominator of the controller. Using the MATLAB command “rlocus”, one can generate a root locus plot as shown in Fig. 5. The complex poles near the imaginary axis have been canceled and more of the root locus is now in the left half plane. This means that a larger controller gain,  $K$ , can be employed, while maintaining stability. The best gain to dampen oscillation and to be far away from unstable region is shown in Fig. 6.

The resulting double lead PSS that cancels the poles near to the imaginary axes with best gain, pushing the poles to the left as far as possible is given below.

$$G_{PSS,notch} = (16.5) \frac{s^2 + 0.248s + 174.255366}{s^2 + 21s + 20} \quad (9)$$

The proposed design will be tested through an actual system in Oman.

#### 4. SIMULATION RESULTS

Power stability can be classified into three types: angle, frequency, and voltage. This section tackles the angle-stability problem. The simulation will demonstrate the effectiveness of the proposed design. The proposed design is applied to the Barka II power station in MIS. More details about power plants in MIS are found in Albadi (2017) and Albadi, El-Rayani *et al.* 2018). Barka II has 5 synchronous generators (3 gas turbines and 2 steam turbines) connected to the grid as shown in Fig. 7.

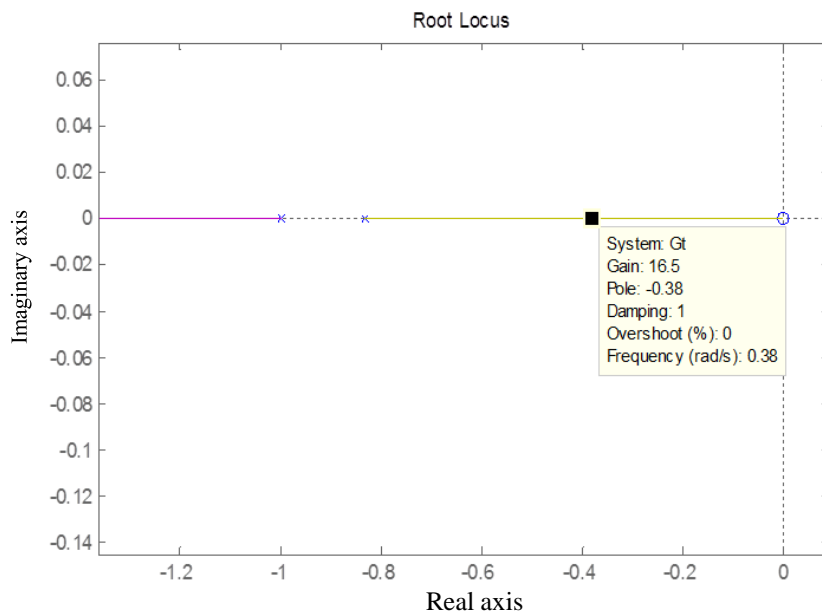

Figure 6. Double lead (Notch filter) power system stabilizer with the best gain.

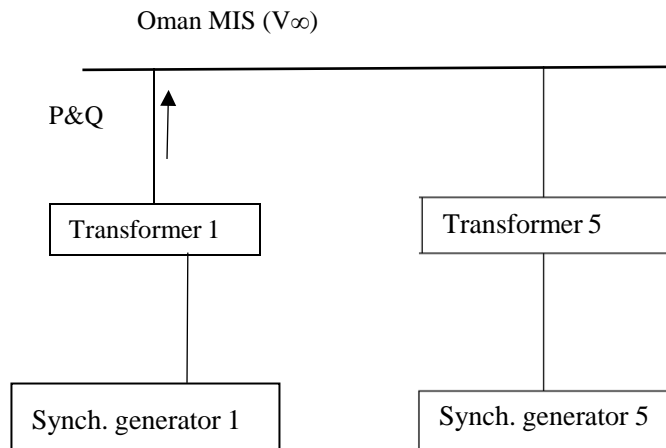

Figure 7. Barka II power station.

**Table 1.** Data of the steam generator in Barka II.

Parameter	Value
$x_d$	2.38 pu
$x_d'$	0.257 pu
$x_q$	2.26 pu
$\omega_0$	314 rad/s
$T_{d0}'$	13.22 s
$H$	1.6 s
$k_e$	25
$T_e$	0.05 s
$X_e$	0.15
$P$	0.6 pu
$Q$	0.3 pu
$V$	1 pu

Manufacturer data sheets, obtained from the Barka II power station, for the steam-turbine generator equipped with a PSS are used to get data required for the simulation. The rest of the four machines in Barka II station and MIS are represented by their Thevenin equivalent. The peak load of 120MW, 60 MVAR, occurs in summer, 2016 is used in the simulation. Considering base values of 200 MVA and 11 kV, the above machine and transformer data are represented in p.u in Table 1.

The linearization of (1-7) around the operating point ( $P=0.6, Q=0.3$ ) can be done analytically or numerically. The analytical method is given as follows (Kundur, Balu *et al.* 1994): To calculate the Heffron-Phillips model parameters, the fourth-order model should be linearized. The linearized form of the model (1-7) is as follows:

$$A = \begin{bmatrix} 0 & \omega_0 & 0 & 0 \\ -\frac{k_1}{M} & 0 & -\frac{k_2}{M} & 0 \\ -\frac{k_4}{T'd_0} & 0 & -\frac{1}{T} & -\frac{1}{T'd_0} \\ -\frac{k_5 k_e}{T_e} & 0 & -\frac{k_6 k_e}{T_e} & -\frac{1}{T_e} \end{bmatrix} \& B = \begin{bmatrix} 0 \\ 0 \\ 0 \\ \frac{k_e}{T_e} \end{bmatrix} \tag{10}$$

In (10),  $k_1, k_2, k_3, k_4, k_5, k_6$ , are constants depending on system parameters and the operating conditions. Analytical expressions for calculating the  $k$ 's are given in Soliman, Elshafei et al. (2000). This model, known as the Heffron-Phillips model, is shown in Fig. 8.

A much easier method for linearization is using the MATLAB/Simulink command "linmod". For the generator peak load (120 MW, 60 MVAR), the corresponding operating condition is [0.6359, 0, 1.2349, 1.9999]. The state-space model is given below:

The response to the same disturbance mentioned before, 0.1 rad, is shown in Fig. 9.

As seen from Fig. 9, the system without PSS takes a long time to dampen the oscillation, which is more than 20s. On the other hand, the system with PSS takes less than 6s to damp the oscillations. It is worth noting that persistent oscillations are very harmful to the system as they decrease the lifetime of generators and can damage the rotor (shaft fatigue).

$$A = \begin{bmatrix} 0 & 314 & 0 & 0 \\ -0.5574 & 0 & -0.4422 & 0 \\ -0.2343 & 0 & -0.4702 & 0.0756 \\ 26.5102 & 0 & -159.5250 & -20.000 \end{bmatrix}$$

$$B = \begin{bmatrix} 0 \\ 0 \\ 0 \\ 500 \end{bmatrix}, C = [0 \ 1 \ 0 \ 0] \& D = [0]$$
(11)

## 5. CONCLUSION

Power system stabilizers have been considered to improve power system damping. The PSS is an auxiliary control system that is applied as part of an excitation control system. This paper proposes a linearized block diagram of a power system with a PSS and the execution of the PSS controller oscillations damping in a SMIB using a small signal model. The system model equations were generated from the phasor diagram of the SMIB and then were linearized using MATLAB/Simulink. The root locus method was used to design the PSS in two stages. In the first stage, a single lead was considered. A much better damping response was achieved by double lead in s stage. A PSS was designed using double lead notch-filter method for actual system in Oman using data of Barka II power station. Simulation results reveal that the designed PSS reduces the system oscillation from 20s to less than 6s.

## CONFLICT OF INTEREST

The authors declare no conflicts of interest.

## FUNDING

No funding was received for this research.

## ACKNOWLEDGMENT

The authors would like to thank SMN Barka Power Plant (Barka II) for their support and collaboration.

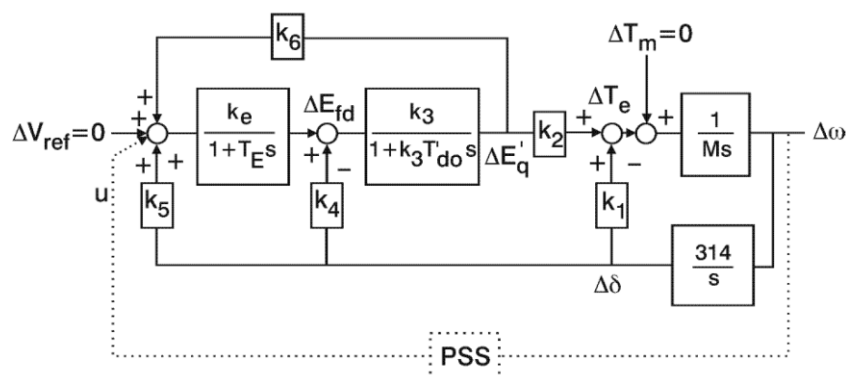

Figure 8. Heffron-Phillips model.

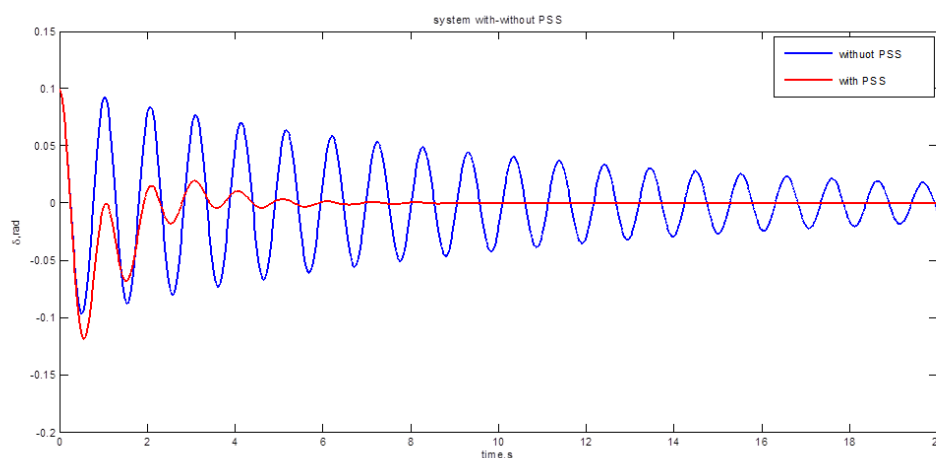

Figure 9. System response without and with proposed notch-filter based power system stabilizer.

## REFERENCES

- Albadi, M. H. (2017), Electricity sector in Oman after 10 years of reform: status, trends, and future perspectives. *The Electricity Journal* 30(7): 23-30.
- Albadi M.H. El-Rayani Y.M. El-Saadany E.F. and Al-Riyami H.A. (2018), Impact of solar power projects on LMP and transmission losses in Oman. *Sustainable Energy Technologies and Assessments* 27: 141-149.
- Castellanos R. A. Messina and Sarmiento H (2008), A  $\mu$ -analysis approach to power system stability robustness evaluation. *Electric Power Systems Research* 78(2): 192-201.
- Elshafei A.L. K. El-Metwally and A. Shaltout (2005), A variable-structure adaptive fuzzy-logic stabilizer for single and multi-machine power systems. *Control Engineering Practice* 13(4): 413-423.
- Feng G (2006), A survey on analysis and design of model-based fuzzy control systems. *IEEE Transactions on Fuzzy Systems* 14(5): 676-697.
- Hussein T. M. Saad A. Elshafei and A. Bahgat (2010), Damping inter-area modes of oscillation using an adaptive fuzzy power system stabilizer. *Electric Power Systems Research* 80(12): 1428-1436.
- Kundur P. N. J. Balu and M. G. Lauby (1994), *Power system stability and control*, McGraw-hill, New York.
- Machowski J. J. Bialek and J. Bumby (2008), *Power system dynamics stability and control*. John Wiley and Sons, Chichester.
- Pal B. and Chaudhuri B (2006), *Robust control in power systems*, Springer Science and Business Media.
- Peres W. I. C. S. Júnior and J. A. Passos Filho (2018), Gradient based hybrid metaheuristics for robust tuning of power system stabilizers. *International Journal of Electrical Power & Energy Systems* 95: 47-72.
- Rahmatian M. and S. Seyedtabaie (2019). Multi-machine optimal power system stabilizers design based on system stability and nonlinearity indices using Hyper-Spherical Search method. *International Journal of Electrical Power and Energy Systems* 105: 729-740.
- Rao P. S. and I. Sen (2000) Robust pole placement stabilizer design using linear matrix inequalities.



- IEEE Transactions on Power Systems* 15(1): 313-319.
- Sauer P.W. and Pai M.A. (1998). Power system dynamics and stability. *Upper Saddle River*, New Jersey: Prentice hall, USA.
- Soliman H. A. Elshafei A. Shaltout and M. Morsi (2000), Robust power system stabiliser. *IEE Proceedings-Generation, Transmission and Distribution* 147(5): 285-291.
- Soliman H. and M. Shafiq (2015), Robust stabilisation of power systems with random abrupt changes. *IET Generation, Transmission and Distribution* 9(15): 2159-2166.
- Soliman H.M.A. Dabroum M. Mahmoud and M. Soliman (2011), Guaranteed-cost reliable control with regional pole placement of a power system. *Journal of the Franklin Institute* 348(5): 884-898.
- Soliman H.M. and K.A. El Metwally (2017), Robust pole placement for power systems using two-dimensional membership fuzzy constrained controllers. *IET Generation, Transmission and Distribution* 11(16): 3966-3973.
- Soliman M. (2014), Parameterization of robust three-term power system stabilizers. *Electric Power Systems Research* 117: 172-184.
- Tanaka K and H. O. Wang (2004), Fuzzy control systems design and analysis: a linear matrix inequality approach, John Wiley and Sons.
- Werner H.P. Korba and T. C. Yang (2003), Robust tuning of power system stabilizers using LMI-techniques. *IEEE Transactions on Control Systems Technology* 11(1): 147-152.